

# SVTM A Series

Brushless Motors



# SVTM A Series

## Brushless Motors

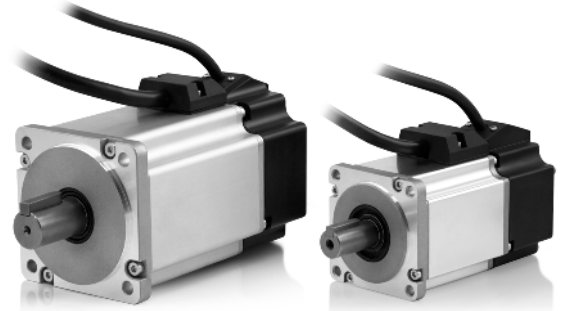

CUSTOMISABLE



LOW VOLTAGE



STURDY

Our Brushless motors (SVTM A Series) feature a type IC 400 construction - this means the motor is totally enclosed and does not need any kind of additional ventilation; this also allows for an IP65 degree of protection on the housing.

To ensure higher service life, most insulating materials are rated in the 200-degree class. In addition, the stator pack design with winding in the groove and using Neodymium magnets ensures high performance with small dimensions, resulting in a sinusoidal electromotive force. For enhanced application safety, a temperature sensor is mounted for each winding so as to prevent damage from overheating and consequently increasing motor service life.

Motors are tested in accordance with EN 60034-18-41 standard relating to partial discharge between windings. To increase the application range, the insulating materials used are UL certified.

All our motors are available with shaft and key. Working voltage options according to customer specifications are available on request. Adjustable connectors (M23 or M17), are mounted in the motors and there may be different wiring and connector solutions.

## Benefits

High efficiency

Many feedback available

Low voltage

IP65 water resistant standard

Many customisation options

Brake option

Many voltage options available

## Certifications

CE

RoHS 2011/65/EUv

## Product code

SVTMA  -  -  -  -  - 

 Series

 Feedback  
resolver [R]; incremental encoder [E]; absolute encoder [A]

 Frame  
01 [60]; 02 [80]; 03 [115]; 04 [145]

 Brake  
no [0]; yes [1]

 Stall torque

 Special options  
Frameless [FML]

 BEMF

## Features

Sealing	IP65* (excluding front shaft)
Winding	3 phase sinusoidal
Operating temperature	-20° +40° C
Tested	EN 60034-18-41**
Insulation class	F, 155° C
Thermal protection	PTC**
Construction	IC 400*
Adjustable connectors	M17 (frame 01) or M23* **
Magnets	Neodymium
Insulators	UL**
Construction technology	high density fractional-slot concentrated-windings
Standard feedback	resolver**, incremental encoder*
Option	brake 24 VDC*

## Feedback\*

Resolver (Standard)\*\*

Incremental encoder with hall (standard) 2500 ppr with hall effect

Other feedbacks available upon request\*\* 2-poles ; 7 Vrms; 10kHz; transformation ratio 0.5;

Absolute single-turn hipurface\*\* SICK SEK 37

Absolute multi-turn hipurface\*\* SICK SEL 37

## Customizations

Cables	Mechanical design	Flange
Materials		

### EN 60034-18-41

Partial discharge free electrical insulation systems (type 1) used in rotating electrical machines fed from voltage converters - qualification and quality control test.

\*Not available for frameless versions

\*Not available for low voltage versions

# SVTM A 01

Values	Unit	SVTM A			
		01-0.87-08-x-x-000	01-0.87-20-x-x-000	01-1.16-12-x-x-000	01-1.16-30-x-x-000
Frame	Ø mm	60	60	60	60
Motor length (L)	mm	125	125	145	145
Motor length with brake	mm	162	162	182	182
Nominal voltage	VDC	60	325/560	60	325/560
Continous stall torque	Nm	0,87	0,87	1,16	1,16
Continous stall current	Arms	7	2,73	6,3	2,45
Nominal torque	Nm	0,79	0,7/0,7	1,08	0,97/0,92
Nominal current	Arms	6,32	2,19/2,19	5,81	2,04/1,94
Nominal speed	rpm	3500	8000/8000	2400	5600/8000
Peak torque	Nm	2,8	2,8	3,9	3,9
Peak current	Arms	28	11	25,5	9,9
Torque constant	Nm/Arms	0,125	0,32	0,186	0,475
BEMF constant (1)(2)	Vrms/krpm	8	20,4	12	30,6
Resistance (1)(2)	Ohm	0,8	5,2	1,06	6,9
Inductance (1)	mH	1,6	10,2	2,3	14,9
Rotor inertia	kgcm <sup>2</sup>	0,22	0,22	0,31	0,31
Max. axial load	N			50	
Max. radial load	N			140	
Feedback (3)	Resolver, encoder inc 2048 + hall, absolute single-turn hiperface (SEK 37), absolute multi-turn hiperface (SEL 37)				
Mass	kg	1.3	1.3	1.6	1.6

(1) Line-line

(2) At 20° C

(3) Length may vary with absolute feedback

Note: Rated values are calculated at 20°C ambient temperature with an heat sink size of 254x254x6.35 mm

All dimensions in millimeters, unless otherwise specified

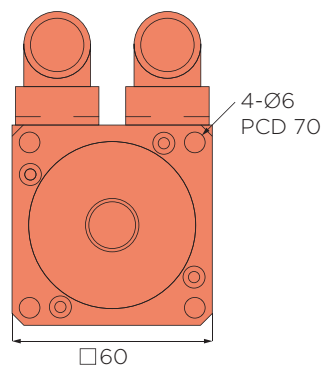
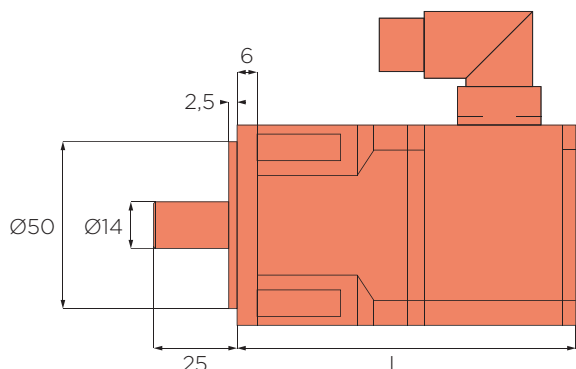
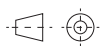

SVTM A 01-0.87-08

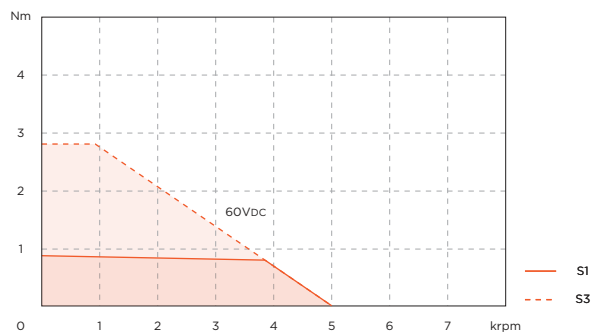

SVTM A 01-0.87-20

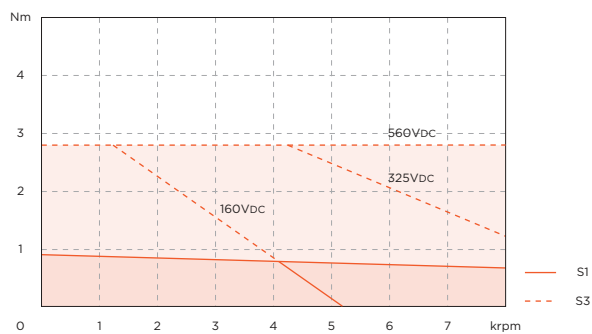

SVTM A 01-1.16-12

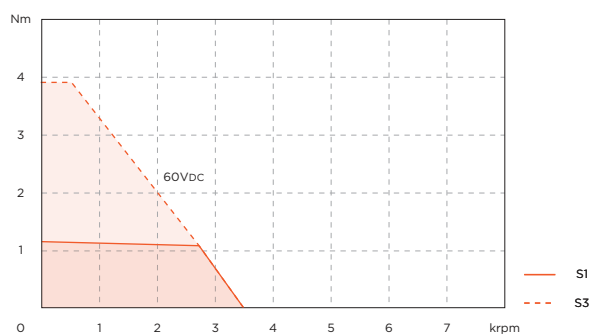

SVTM A 01-1.16-30

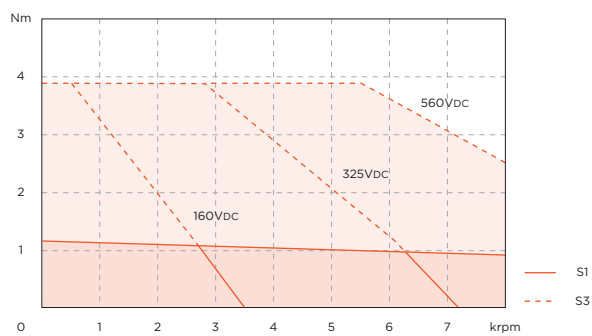

**Note:**

Rated values are calculated at 20°C ambient temperature with an heat sink size of 254x254x6.35 mm. See next page for frameless version.

# SVTM A 01

## Low Voltage

Values	Unit	SVTM A 01	
		A 01-0.7-06-E-X-000	A 01-1.4-06-E-X-000
Frame	Ø mm	60	60
Motor length (L)	mm	110	135
Motor length with brake	mm	150	175
Nominal voltage	VDC	48	48
Continuous stall torque	Nm	0.7	1.4
Continuous stall current	Arms	6.6	13.2
Nominal torque	Nm	0.64	1.27
Nominal current	Arms	6	12
Nominal speed	rpm	3000	3000
Peak torque	Nm	1.92	3.81
Peak current	Arms	18	36
Torque constant	Nm/Arms	0.107	0.107
BEMF constant (1)(2)	Vrms/krpm	6.5	6.5
Resistance (1)(2)	Ohm	0.56	0.25
Inductance (1)	mH	1.2	0.55
Rotor inertia	kgcm <sup>2</sup>	0.21	0.43
Max. axial load	N	98	98
Max. radial load	N	245	245
Feedback	Encoder inc 2500 + hall		
Mass	kg	1.4	1.7

(1) Line-line

(2) At 20° C

Note: Rated values are calculated at 20°C ambient temperature with an heat sink size of 254x254x6.35 mm

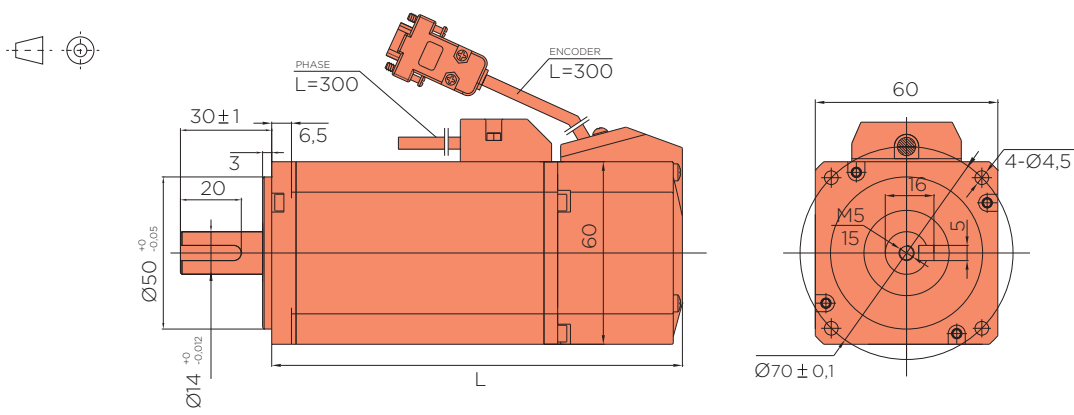

SVTM A 01-0.7-06-E-X-000

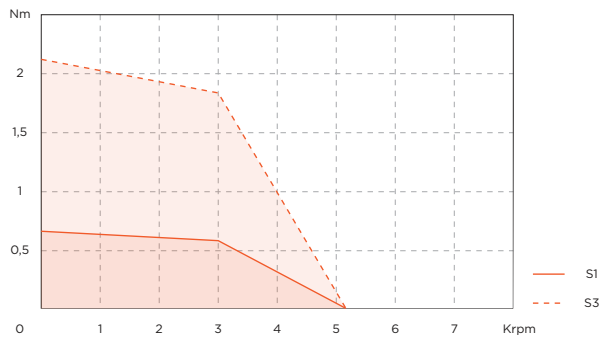

SVTM A 01-1.4-06-E-X-000

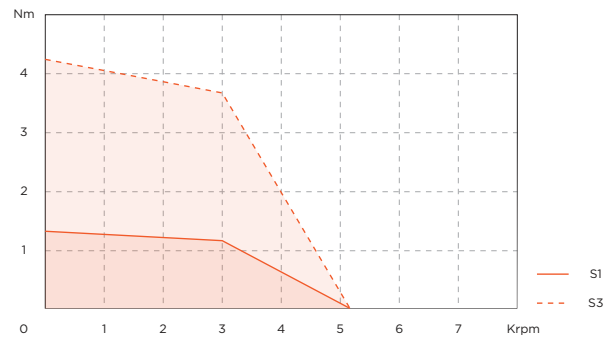

**Note:**

Rated values are calculated at 20°C ambient temperature with an heat sink size of 254x254x6.35 mm. See next page for frameless version.



# SVTM A 01 ..FML

## Frameless

Values	Unit	SVTM A			
		01-0.87-08-0-FML	01-0.87-20-0-FML	01-1.16-12-0-FML	01-1.16-30-0-FML
Frame	Ø mm	56	56	56	56
Motor length (L)	mm	40	40	60	60
Nominal voltage	V	60	325/560	60	325/560
Continuous stall torque	Nm	0,87	0,87	1,16	1,16
Continuous stall current	Arms	7	2,73	6,3	2,45
Nominal torque	Nm	0,79	0,7/0,7	1,08	0,97/0,92
Nominal current	A	6,32	2,19/2,19	5,81	2,04/1,94
Nominal speed	rpm	3500	8000/8000	2400	5600/8000
Peak torque	Nm	2,8	2,8	3,9	3,9
Peak current	Arms	28	11	25,5	9,9
Torque constant	Nm/Arms	0,125	0,32	0,186	0,475
BEMF constant (1)(2)	Vrms/krpm	8	20,4	12	30,6
Resistance (1)(2)	Ohm	0,8	5,2	1,06	6,9
Inductance (1)	mH	1,6	10,2	2,3	14,9
Rotor inertia	kgcm <sup>2</sup>	0,18	0,18	0,27	0,27
Poles		6	6	6	6
Mass	kg	0,7	0,7	1	1
Thermal protection		PTC	PTC	PTC	PTC

(1) Line-line

(2) At 20° C

Note: Rated values are calculated at 20°C ambient temperature with an heat sink size of 305x305x12,7 mm

All dimensions in millimeters, unless otherwise specified

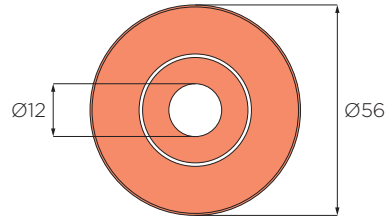
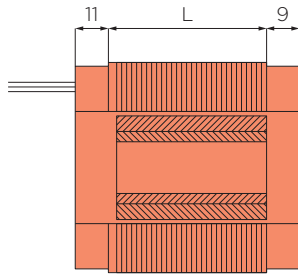

SVTM A 01-0.87-08-0-FML

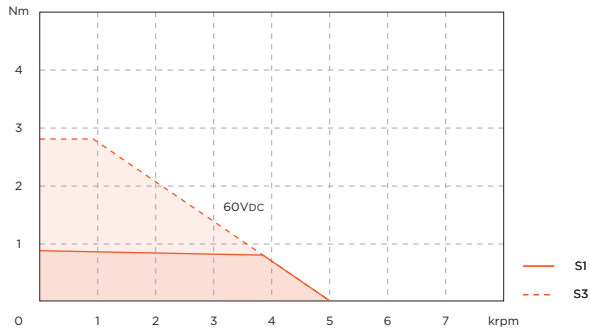

SVTM A 01-0.87-20-0-FML

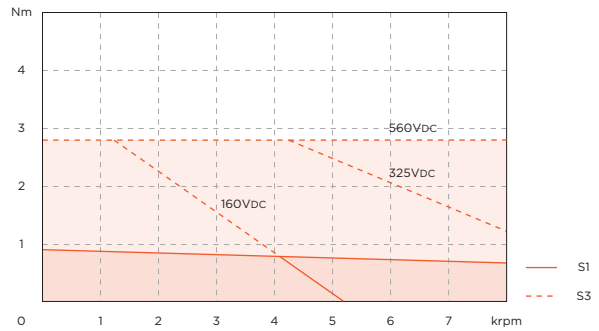

SVTM A 01-1.16-12-0-FML

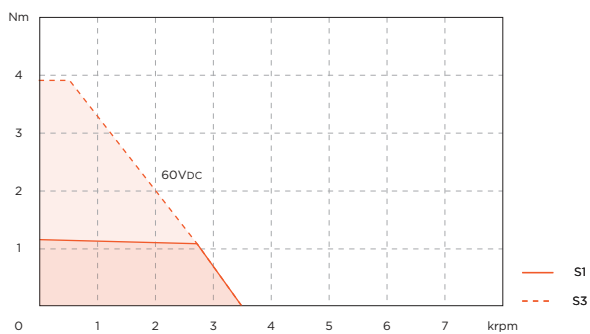

SVTM A 01-1.16-30-0-FML

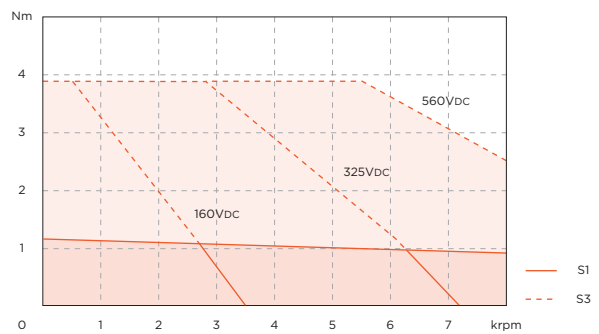

**Note:**

Rated values are calculated at 25°C ambient temperature, housed motor with an heat sink size of 254x254x6.35 mm. See previous page for framed version.

# SVTM A 02

Values	Unit	SVTM A			
		02-1.74-12-x-x-000	02-1.85-36-x-x-000	02-3.00-25-x-x-000	02-3.18-57-x-x-000
Frame	Ø mm	80	80	80	80
Motor length (L)	mm	125	125	155	155
Motor length with brake	mm	166	166	203	203
Nominal voltage	VDC	80	325/560	150	325/560
Continuous stall torque	Nm	1,74	1,85	3	3,18
Continuous stall current	Arms	9	3,3	7,7	3,55
Nominal torque	Nm	1,44	1,48/1,32	2,4	2,55/2,1
Nominal current	Arms	7,35	2,60/2,32	6,19	2,85/2,35
Nominal speed	rpm	3400	4750/8000	3400	3200/5400
Peak torque	Nm	6,3	6,3	11,5	11,5
Peak current	Arms	38,7	13,3	34,3	14,9
Torque constant	Nm/Arms	0,196	0,57	0,388	0,895
BEMF constant (1)(2)	Vrms/krpm	12,5	36,4	25	57,6
Resistance (1)(2)	Ohm	0,6	4,4	0,92	4,35
Inductance (1)	mH	1,45	13,3	2,9	14,8
Rotor inertia	kg/cm <sup>2</sup>	0,8	0,8	1,5	1,5
Max. axial load	N	110	110	110	110
Max. radial load	N	330	330	330	330
Thermal protection		PTC	PTC	PTC	PTC
Feedback (3)	Resolver, encoder inc 2048 + hall, absolute single-turn hiperface (SEK 37), absolute multi-turn hiperface (SEL 37)				
Mass	kg	2.3	2.3	3.3	3.3

Values	Unit	SVTM A	
		02-4.10-37-x-x-000	02-4.39-77-x-x-000
Frame	Ø mm	80	80
Motor length (L)	mm	185	185
Motor length with brake	mm	233	233
Nominal voltage	VDC	150	325/560
Continuous stall torque	Nm	4,1	4,39
Continuous stall current	Arms	7,1	3,67
Nominal torque	Nm	3,26	3,64/3,06
Nominal current	Arms	5,62	3,04/2,56
Nominal speed	rpm	2200	2300/4100
Peak torque	Nm	16,3	16,3
Peak current	Arms	32,8	16
Torque constant	Nm/Arms	0,58	1,196
BEMF constant (1)(2)	Vrms/krpm	37,5	77
Resistance (1)(2)	Ohm	1,25	4,6
Inductance (1)	mH	3,7	17,4
Rotor inertia	kgcm <sup>2</sup>	2,25	2,25
Max. axial load	N	110	110
Max. radial load	N	330	330
Thermal protection		PTC	PTC
Feedback (3)	Resolver, encoder inc 2048 + hall, absolute single-turn hiperface (SEK 37), absolute multi-turn hiperface (SEL 37)		
Mass	kg	4.3	

(1) Line-line

(2) At 20° C

(3) Length may vary with absolute feedback

Note: Rated values are calculated at 20°C ambient temperature with an heat sink size of 254x254x6.35 mm

All dimensions in millimeters, unless otherwise specified

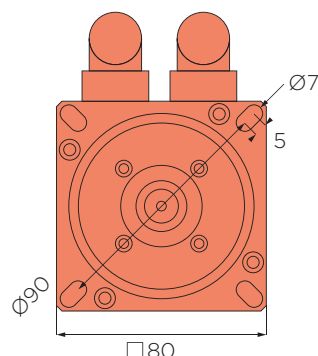
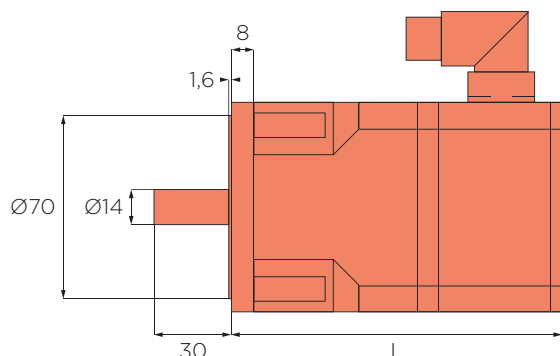
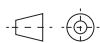

SVTM A 02-1.74-12

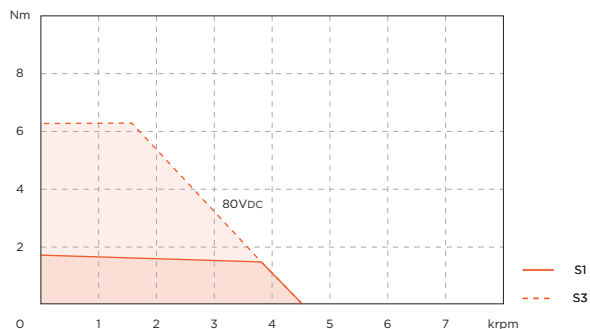

SVTM A 02-1.85-36

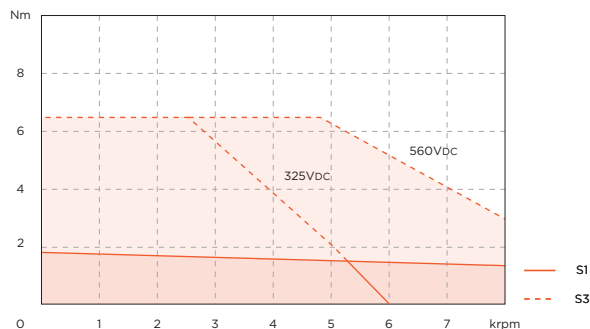

SVTM A 02-3.18-57

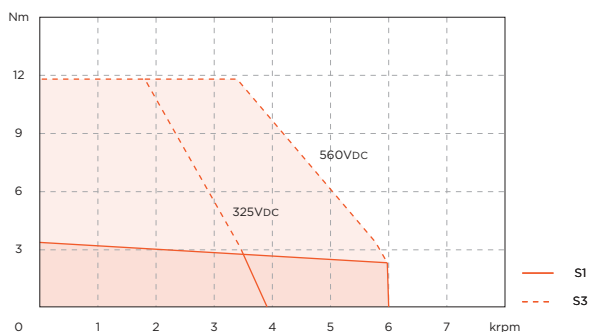

SVTM A 02-3.00-25

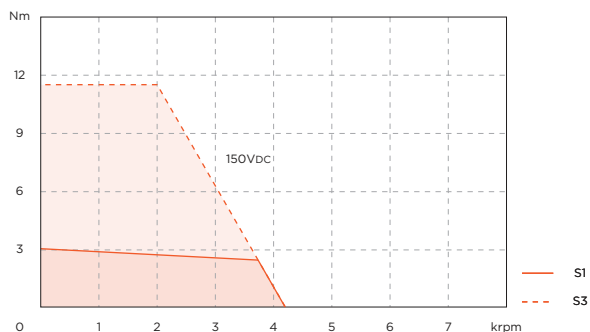

SVTM A 02-4.10-37

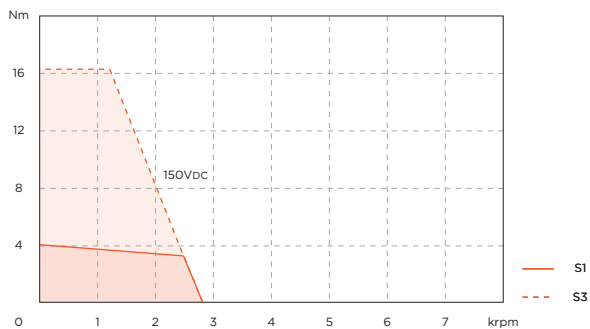

SVTM A 02-4.39-77

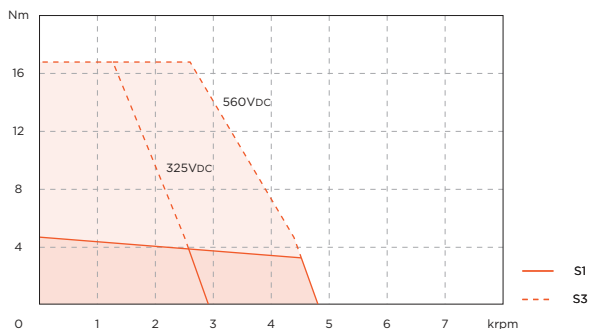

**Note:**

Rated values are calculated at 20°C ambient temperature with an heat sink size of 254x254x6.35 mm. See next page for frameless version.

All dimensions in millimeters, unless otherwise specified

# SVTM A 02

## Low Voltage

Values	Unit	SVTM A 02	
		A 02-2.62-06-E-X-000	A 02-3.52-06-E-X-000
Frame	Ø mm	80	80
Motor length (L)	mm	142	162
Motor length with brake	mm	182	202
Nominal voltage	VDC	48	48
Continuous stall torque	Nm	2.62	3.52
Continuous stall current	Arms	24.4	33
Nominal torque	Nm	2.38	3.2
Nominal current	Arms	22.2	30
Nominal speed	rpm	3000	3000
Peak torque	Nm	7.14	9.6
Peak current	Arms	66.6	90
Torque constant	Nm/Arms	0.107	0.107
BEMF constant (1)(2)	Vrms/krpm	6.5	6.5
Resistance (1)(2)	Ohm	0.05	0.042
Inductance (1)	mH	0.28	0.16
Rotor inertia	kgcm <sup>2</sup>	1.24	1.7
Max. axial load	N	147	147
Max. radial load	N	392	392
Feedback	Encoder inc 2500 + hall		
Mass	kg	2.4	3.8

(1) Line-line

(2) At 20° C

Note: Rated values are calculated at 20°C ambient temperature with an heat sink size of 254x254x6.35 mm

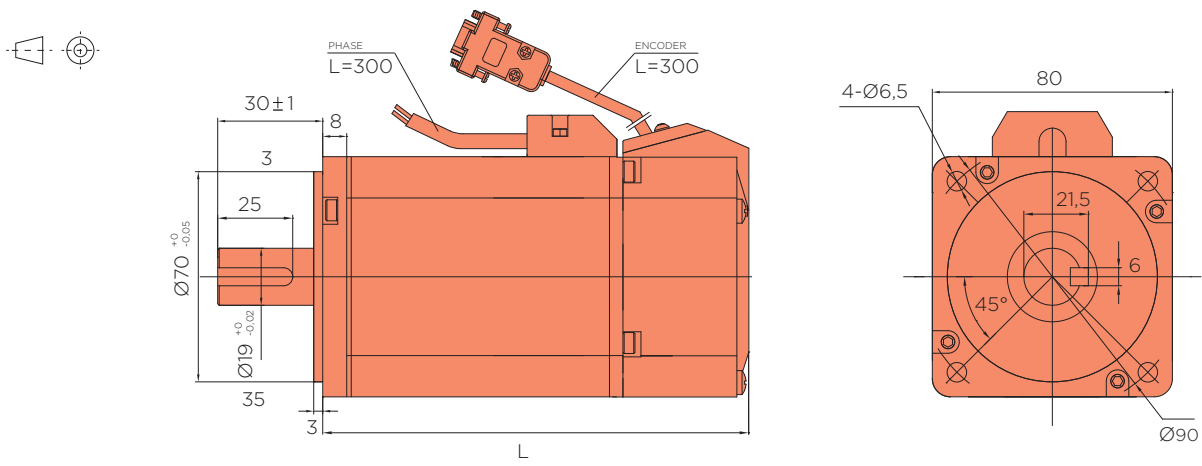

SVTM A 02-2.62-06-E-X-000

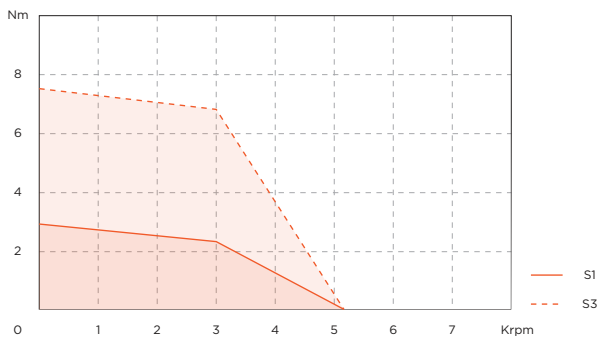

SVTM A 02-3.52-06-E-X-000

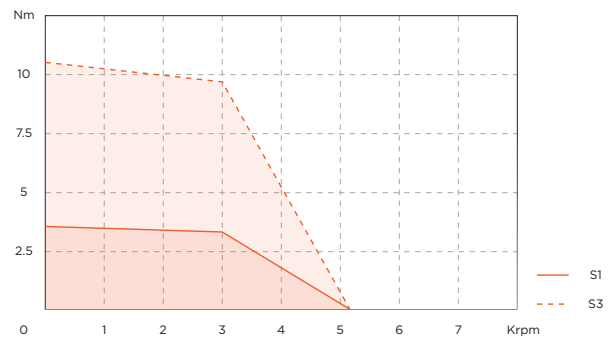

**Note:**

Rated values are calculated at 20°C ambient temperature with an heat sink size of 254x254x6.35 mm. See next page for frameless version.

# SVTM A 02 ..FML

## Frameless

Values	Unit	SVTM A			
		02-1.74-12-0-FML	02-1.85-36-0-FML	02-3.00-25-0-FML	02-3.18-57-0-FML
Frame	Ø mm	76	76	76	76
Motor length (L)	mm	30	30	60	60
Nominal voltage	VDC	80	325/560	150	325/560
Continous stall torque	Nm	1,74	1,85	3	3,18
Continous stall current	Arms	9	3,3	7,7	3,55
Nominal torque	Nm	1,44	1,48/1,32	2,4	2,55/2,1
Nominal current	Arms	7,35	2,60/2,32	6,19	2,85/2,35
Nominal speed	rpm	3400	4750/8000	3400	3200/5400
Peak torque	Nm	6,3	6,3	11,5	11,5
Peak current	Arms	38,7	13,3	34,3	14,9
Torque constant	Nm/Arms	0,196	0,57	0,388	0,895
BEMF constant (1)(2)	Vrms/krpm	12,5	36,4	25	57,6
Resistance (1)(2)	Ohm	0,6	4,4	0,92	4,35
Inductance (1)	mH	1,45	13,3	2,9	14,8
Rotor inertia	kg/cm2	0,69	0,69	1,38	1,38
Poles		6	6	6	6
Mass	kg	0,9	0,9	1,7	1,7
Thermal protection		PTC	PTC	PTC	PTC

Values	Unit	SVTM A	
		02-4.10-37-0-FML	02-4.39-077-0-FML
Frame	Ø mm	76	76
Motor length (L)	mm	90	90
Nominal voltage	VDC	150	325/560
Continous stall torque	Nm	4,1	4,39
Continous stall current	Arms	7,1	3,67
Nominal torque	Nm	3,26	3,64/3,06
Nominal current	Arms	5,62	3,04/2,56
Nominal speed	rpm	2200	2300/4100
Peak torque	Nm	16,3	16,3
Peak current	Arms	32,8	16
Torque constant	Nm/Arms	0,58	1,196
BEMF constant (1)(2)	Vrms/krpm	37,5	77
Resistance (1)(2)	Ohm	1,25	4,6
Inductance (1)	mH	3,7	17,4
Rotor inertia	kgcm <sup>2</sup>	2,08	2,08
Poles		6	6
Mass	kg	2,5	2,5
Thermal protection		PTC	PTC

Feedback

(1) Line-line

(2) At 20° C

Note: Rated values are calculated at 20°C ambient temperature with an heat sink size of 305x305x12,7 mm

All dimensions in millimeters, unless otherwise specified

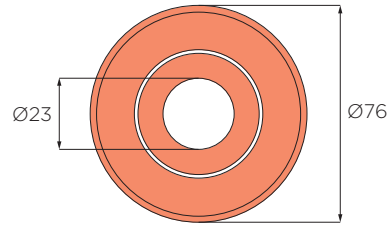
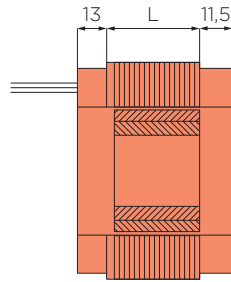

SVTM A 02-1.74-12-0-FML

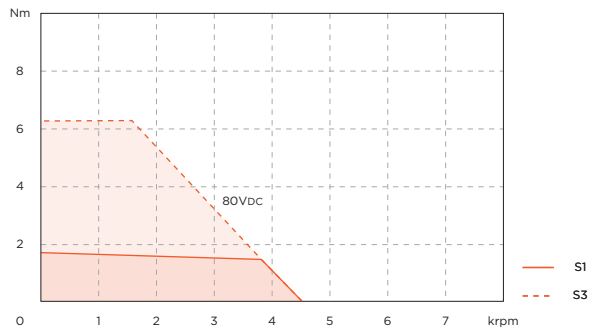

SVTM A 02-1.85-36-0-FML

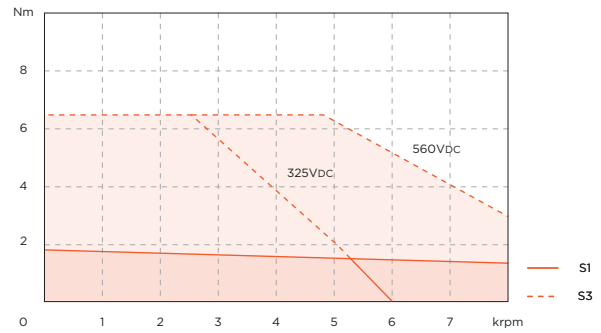

SVTM A 02-3.00-25-0-FML

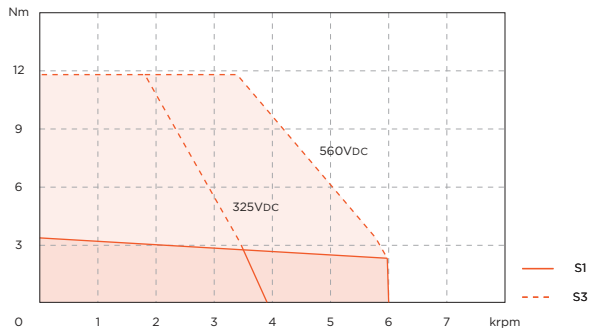

SVTM A 02-3.18-57-0-FML

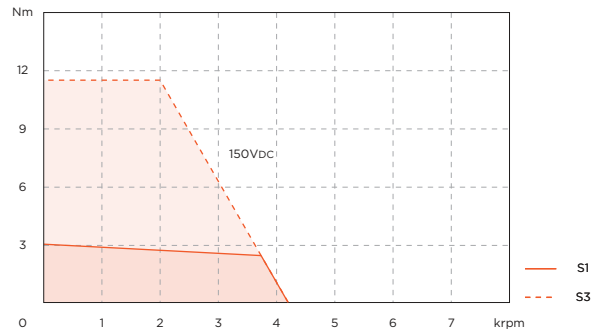

SVTM A 02-4.10-37-0-FML

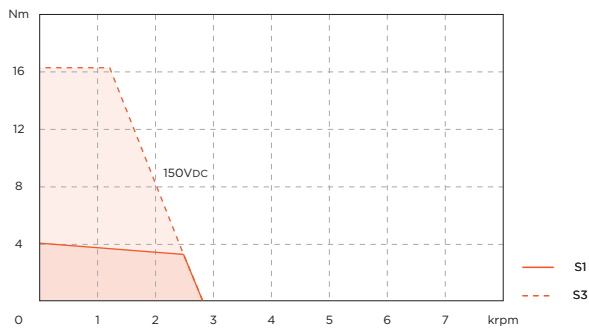

SVTM A 02-4.39-077-0-FML

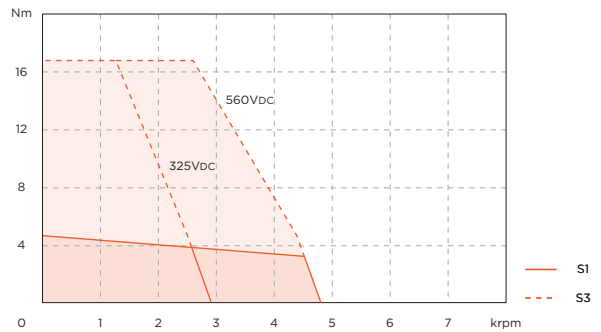

**Note:**

Rated values are calculated at 25°C ambient temperature, housed motor with an heat sink size of 254x254x6.35 mm. See previous page for framed version.



# SVTM A 03

Values	Unit	SVTM A			
		03-4.90-61-x-x-000	03-8.60-105-x-x-000	03-11.5-107-x-x-000	03-14.4-120-x-x-000
Frame	Ø mm	115	115	115	115
Motor length (L)	mm	156	187	218	249
Motor length with brake	mm	204	235	270	301
Nominal voltage	VDC	325/560	560	560	560
Continuous stall torque	Nm	4,9	8,6	11,5	14,4
Continuous stall current	Arms	5,1	5,25	6,85	7,7
Nominal torque	Nm	3,74/2,93	7,0	9,3	11,1
Nominal current	Arms	3,91/3,06	4,24	5,54	5,96
Nominal speed	rpm	2900/4900	2900	2800	2500
Peak torque	Nm	12	22	30	38
Peak current	Arms	15,5	15,8	21	23,3
Torque constant	Nm/Arms	0,956	1,64	1,68	1,87
BEMF constant (1)(2)	Vrms/krpm	61,6	105,6	107	120,5
Resistance (1)(2)	Ohm	2,6	2,95	1,86	1,59
Inductance (1)	mH	12,7	18,7	12,8	12,1
Rotor inertia	kgcm <sup>2</sup>	3,7	7,2	10,8	14,4
Max. axial load	N	210	210	210	210
Max. radial load	N	630	630	630	630
Thermal protection		PTC	PTC	PTC	PTC
Feedback (3)		Resolver, encoder inc 2048 + hall, absolute single-turn hipurface (SEK 37), absolute multi-turn hipurface (SEL 37)			
Mass	kg	4	6.5	9.5	12.5

(1) Line-line

(2) At 20° C

(3) Length may vary with absolute feedback

Note: Rated values are calculated at 20°C ambient temperature with an heat sink size of 305x305x12,7 mm

All dimensions in millimeters, unless otherwise specified

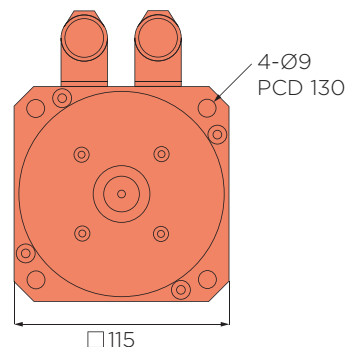
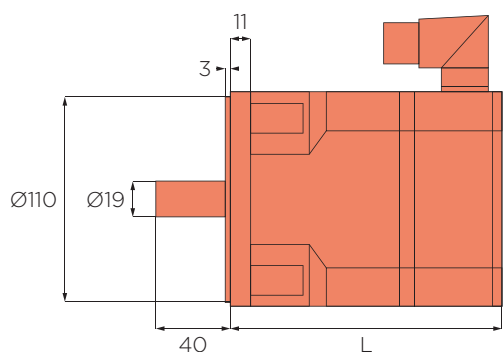
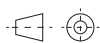

SVTM A 03-4.90-61

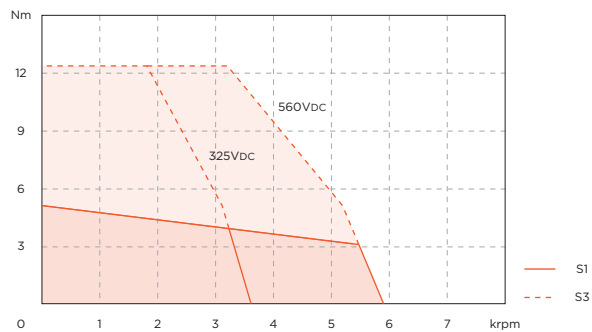

SVTM A 03-8.60-105

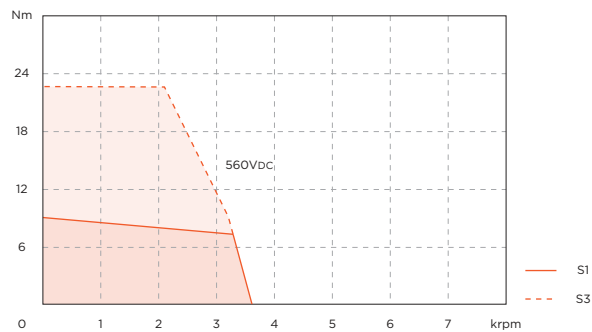

SVTM A 03-11.5-107

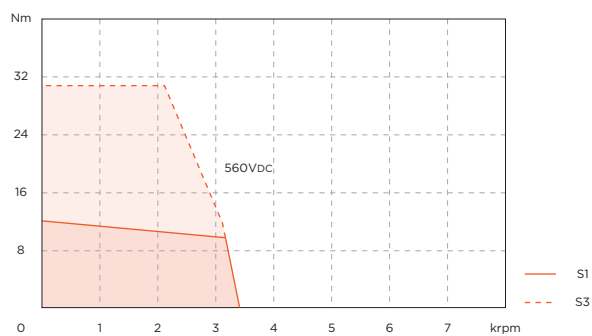

SVTM A 03-14.4-120

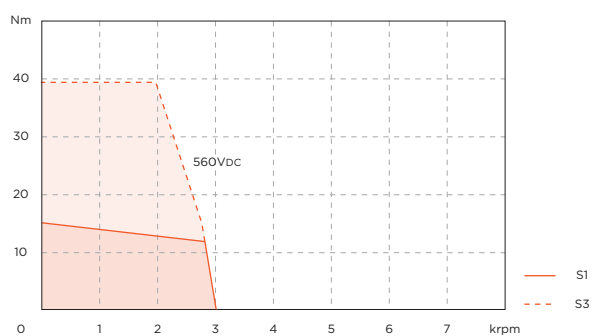

**Note:**

Rated values are calculated at 20°C ambient temperature with an heat sink size of 254x254x6.35 mm. See next page for frameless version.

# SVTM A 03 ..FML

## Frameless

Values	Unit	SVTM A			
		03-4.90-061-0-FML	03-8.60-105-0-FML	03-11.5-107-0-FML	03-14.4-120-0-FML
Frame	Ø mm	106.5	106.5	106.5	106.5
Motor length (L)	mm	31	62	93	124
Nominal voltage	VDC	325/560	560	560	560
Continous stall torque	Nm	4,9	8,6	11,5	14,4
Continous stall current	Arms	5,1	5,25	6,85	7,7
Nominal torque	Nm	3,74/2,93	7,0	9,3	11,1
Nominal current	Arms	3,91/3,06	4,24	5,54	5,96
Nominal speed	rpm	2900/4900	2900	2800	2500
Peak torque	Nm	12	22	30	38
Peak current	Arms	15,5	15,8	21	23,3
Torque constant	Nm/Arms	0,956	1,64	1,68	1,87
BEMF constant (1)(2)	Vrms/krpm	61,6	105,6	107	120,5
Resistance (1)(2)	Ohm	2,6	2,95	1,86	1,59
Inductance (1)	mH	12,7	18,7	12,8	12,1
Rotor inertia	kgcm <sup>2</sup>	2,88	5,76	8,64	11,5
Poles		10	10	10	10
Mass	kg	1,9	3,7	5,5	7,3
Thermal protection		PTC	PTC	PTC	PTC

(1) Line-line

(2) At 20° C

Note: Rated values are calculated at 20°C ambient temperature with an heat sink size of 305x305x12,7 mm

All dimensions in millimeters, unless otherwise specified

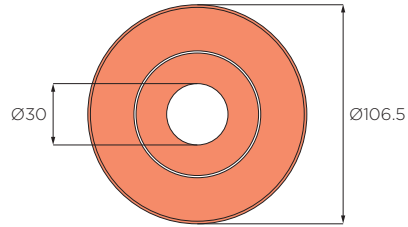
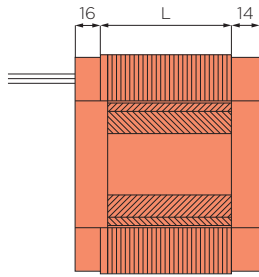

SVTM A 03-4.90-061-0-FML

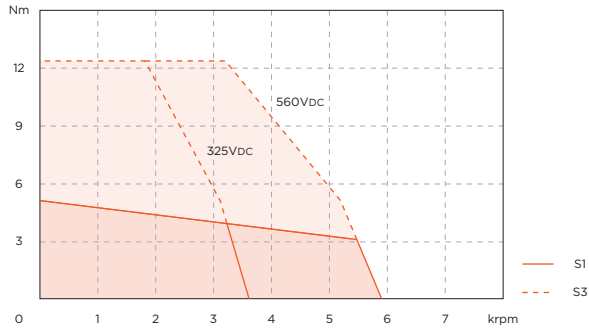

SVTM A 03-8.60-105-0-FML

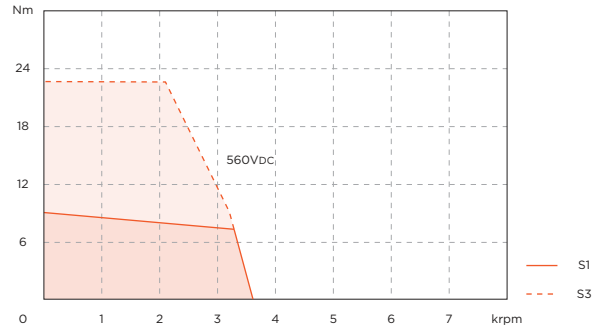

SVTM A 03-11.5-107-0-FML

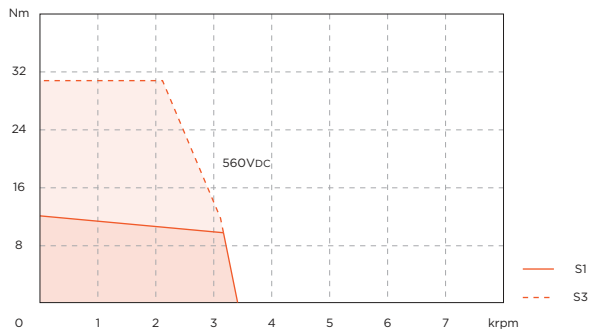

SVTM A 03-14.4-120-0-FML

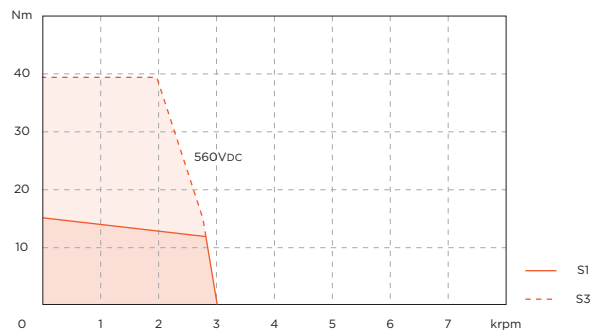

**Note:**

Rated values are calculated at 25°C ambient temperature, housed motor with an heat sink size of 254x254x6.35 mm. See previous page for framed version.

# SVTM A 04

Values	Unit	SVTM A			
		04-12.2-82-x-x-000	04-16.8-110-x-x-000	04-21.0-107-x-x-000	04-24.3-88-x-x-000
Frame	Ø mm	145	145	145	145
Motor length (L)	mm	175	200	225	250
Motor length with brake	mm	227	252	283	308
Nominal voltage	VDC	560	560	560	560
Continous stall torque	Nm	12,2	16,8	21	24,3
Continous stall current	Arms	9,6	9,9	12,8	17,8
Nominal torque	Nm	8,6	12,9	15,6	15,0
Nominal current	Arms	6,74	7,53	9,40	10,88
Nominal speed	rpm	3600	2800	2800	3500
Peak torque	Nm	30,1	42,6	54,1	63,7
Peak current	Arms	28,7	29,7	38,4	53,3
Torque constant	Nm/Arms	1,28	1,71	1,66	1,38
BEMF constant (1)(2)	Vrms/krpm	82,1	110	107	88,8
Resistance (1)(2)	Ohm	1,05	1,09	0,71	0,42
Inductance (1)	mH	10,5	12	8,5	4,7
Rotor inertia	kgcm <sup>2</sup>	14	20,75	27,5	34,25
Max. axial load	N	430	430	430	430
Max. radial load	N	1300	1300	1300	1300
Thermal protection		PTC	PTC	PTC	PTC
Feedback (3)		Resolver, encoder inc 2048 + hall, absolute single-turn hiperface (SEK 37), absolute multi-turn hiperface (SEL 37)			
Mass	kg	10	12.2	14.4	16.6

(1) Line-line

(2) At 20° C

(3) Length may vary with absolute feedback

Note: Rated values are calculated at 20°C ambient temperature with an heat sink size of 457x457x12,5 mm

All dimensions in millimeters, unless otherwise specified

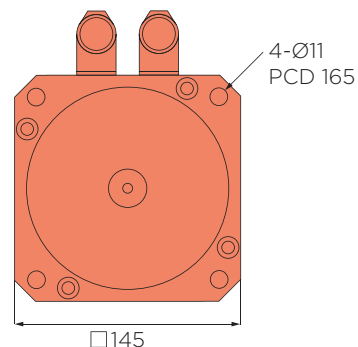
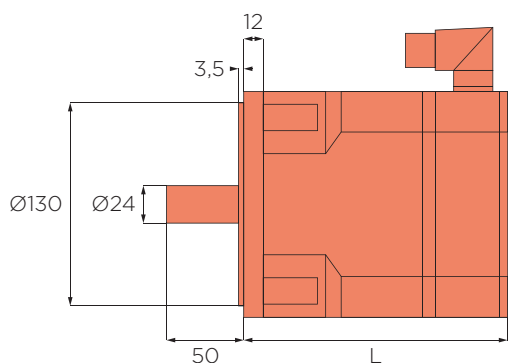
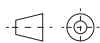

SVTM A 04-12.2-82

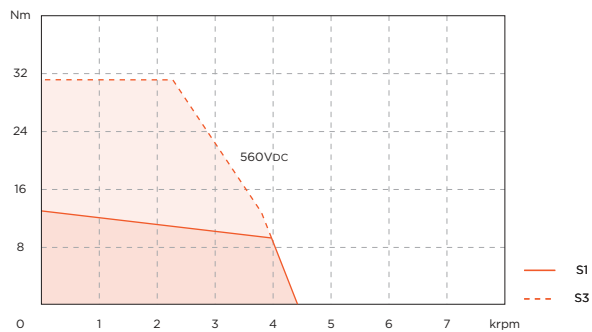

SVTM A 04-16.8-110

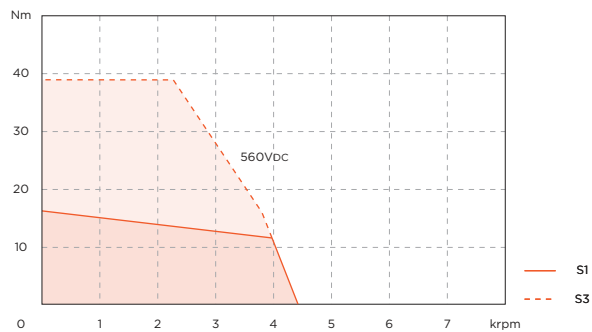

SVTM A 04-21.0-107

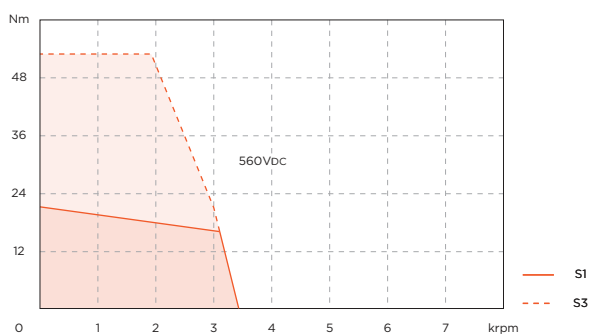

SVTM A 04-24.3-88

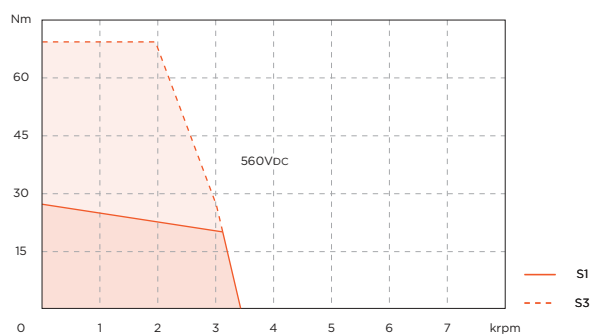

**Note:**

Rated values are calculated at 20°C ambient temperature with an heat sink size of 254x254x6.35 mm. See next page for frameless version.

# SVTM A 04 ..FML

## Frameless

Values	Unit	SVTM A			
		04-12.2-082-0-FML	04-16.8-110-0-FML	04-21.0-107-0-FML	04-24.3-088-0-FML
Frame	Ø mm	136	136	136	136
Motor length (L)	mm	50	75	100	125
Nominal voltage	VDC	560	560	560	560
Continous stall torque	Nm	560	560	560	560
Continous stall current	Arms	12,2	16,8	21	24,3
Nominal torque	Nm	9,6	9,9	12,8	17,8
Nominal current	A	6,74	7,53	9,40	10,88
Nominal speed	rpm	3600	2800	2800	3500
Peak torque	Nm	30,1	42,6	54,1	63,7
Peak current	Arms	28,7	29,7	38,4	53,3
Torque constant	Nm/Arms	1,28	1,71	1,66	1,38
BEMF constant (1)(2)	Vrms/krpm	82,1	110	107	88,8
Resistance (1)(2)	Ohm	1,05	1,09	0,71	0,42
Inductance (1)	mH	10,5	12	8,5	4,7
Rotor inertia	kgcm <sup>2</sup>	10,1	15,1	20,2	25,5
Poles		10	10	10	10
Mass	kg	4,7	7	9,3	11,6
Thermal protection		PTC	PTC	PTC	PTC

(1) Line-line

(2) At 20° C

Note: Rated values are calculated at 20°C ambient temperature with an heat sink size of 457x457x12,5 mm

All dimensions in millimeters, unless otherwise specified

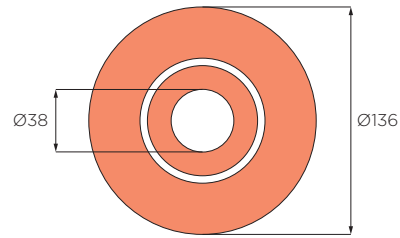
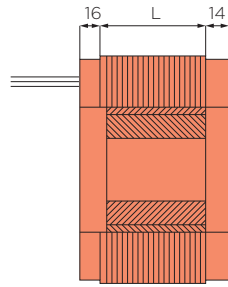

SVTM A 04-12.2-082-0-FML

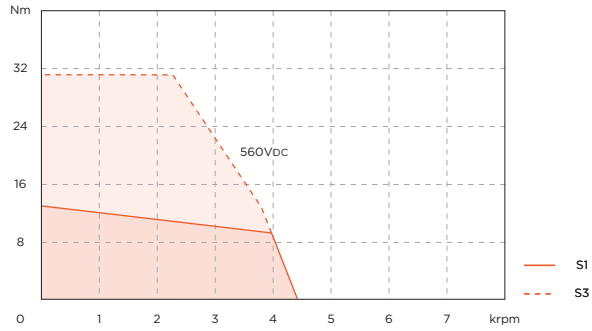

SVTM A 04-16.8-110-0-FML

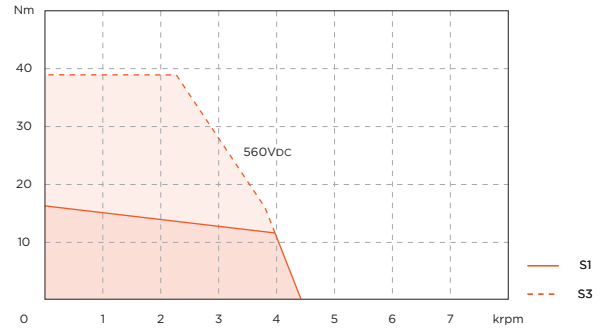

SVTM A 04-21.0-107-0-FML

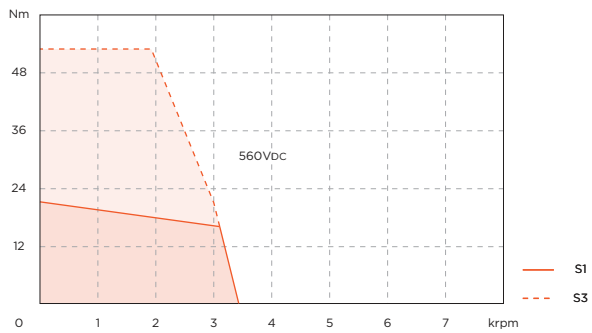

SVTM A 04-24.3-088-0-FML

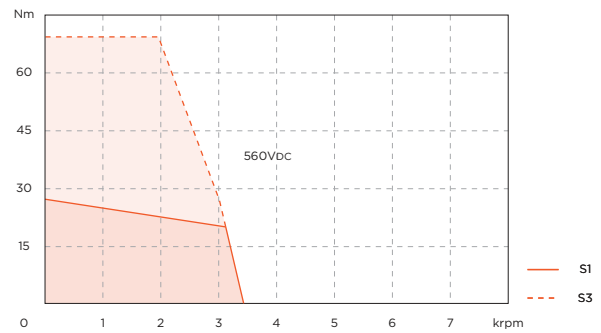

**Note:**

Rated values are calculated at 25°C ambient temperature, housed motor with an heat sink size of 254x254x6.35 mm. See previous page for framed version.