

[Return to Table of Contents](#)

GSX SERIES

INTEGRATED SERVO MOTOR AND ACTUATOR

High quality screw for longer life

Ideal hydraulic replacement

Powerful and robust

Compact size

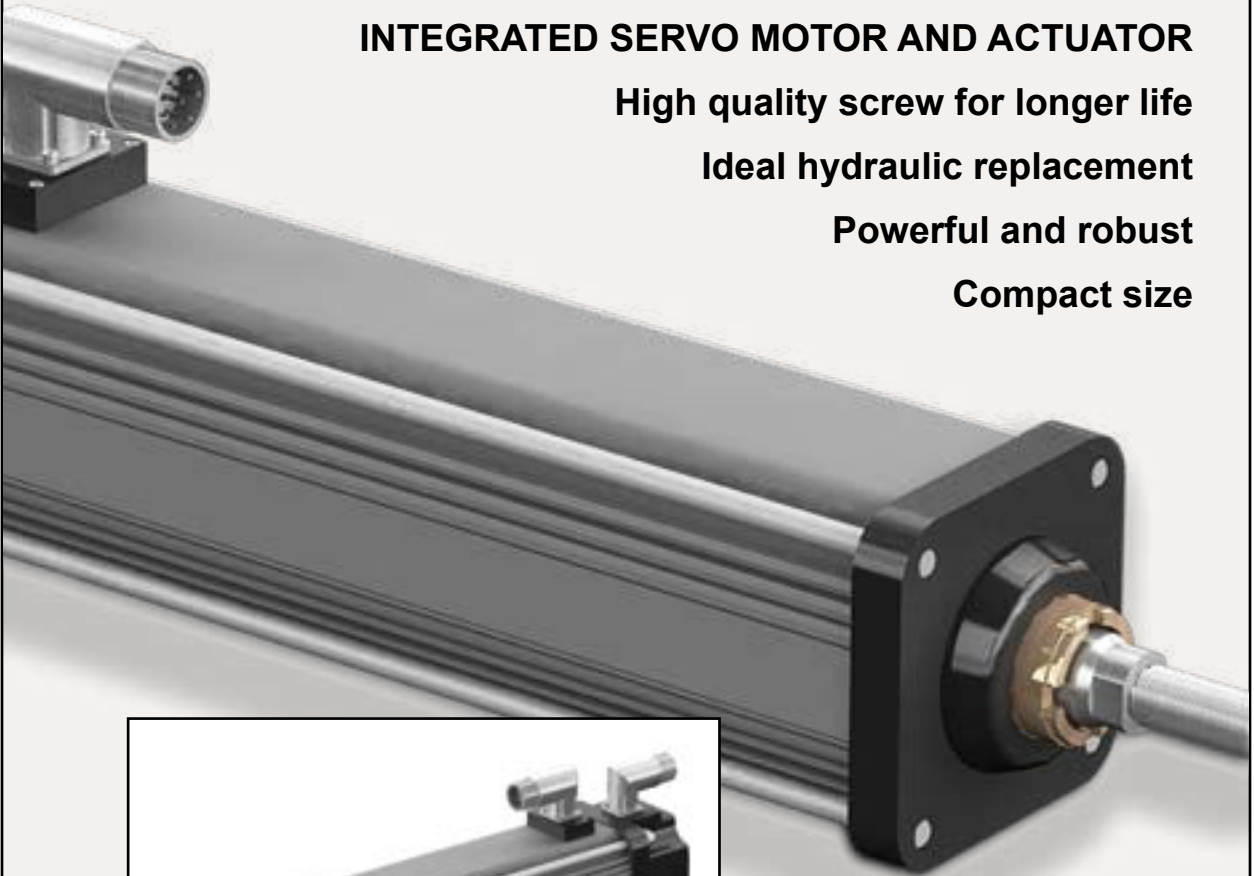

GSX Series Integrated Motor/Actuator

GSX Series

High Capacity Integrated Motor/Actuator

Description

For applications that require long life and continuous duty, even in harsh environments, the GSX Series actuator offers a robust solution. The life of these actuators can exceed that of a ball screw actuator by 15 times, all while delivering high speeds and high forces.

Sealed for Long Life with Minimum Maintenance

GSX Series actuators have strong advantages wherever outside contaminants are an issue. In most rotary-to-linear devices, critical mechanisms are exposed to the environment. Thus, these actuators must be frequently inspected, cleaned and lubricated.

In contrast, the converting components in all Exlar GSX units are mounted within sealed motor housing. With a simple bushing and seal on the smooth extending rod, abrasive particles or other contaminants are prevented from reaching the actuator's critical mechanisms. This assures trouble-free operation even in the most harsh environments.

Similarly, lubrication requirements are minimal. GSX actuators can be lubricated with either grease or recirculated oil. Recirculated oil systems eliminate this type of maintenance altogether. A GSX Series actuator with a properly operating recirculating oil system will operate indefinitely, without any other lubrication requirements.

Feature	Standard	Optional
External anti-rotate mechanism	No	Yes
Internal Anti-rotate Mechanism	No	Yes
Electric brake	No	Yes
External Limit Switches	No	Yes
Connectors	Right Angle, Rotatable	
Mounting Style	Extended Tie Rods, Side Tapped Mounting Holes, Trunnion, Rear Clevis, Front or Rear Flange	
Rod End	Male or Female: U.S. Standard or Metric	Specials available to meet OEM requirements
Lubrication	Greased, Oil Connection Ports are Built-in for Customer Supplied Recirculated Oil Lubrication	
Primary Feedback	Standard Encoders or Resolvers to Meet Most Amplifier Requirements	

Technical Characteristics	
Frame Sizes in (mm)	2 (50.8), 3 (76.2), 4 (101.6), 5.5 (139.7), 7 (177.8)
Screw Leads in (mm)	0.1 (2), 0.2 (5), 0.25 (6), 0.4 (10), 0.5 (13), 0.75 (19), 1 (25)
Standard Stroke Lengths	3 (76), 4 (102), 6 (152), 8 (203), 10 (254), 12 (305), 14 (357), 18 (457)
Force Range	103 to 11,528 lbf (458 to 51 kN)
Maximum Speed	up to 37.5 in/sec (952 mm/s)

Operating Conditions and Usage		
Accuracy:		
Screw Lead Error	in/ft (µm / 300 mm)	0.001 (25)
Screw Travel Variation	in/ft (µm / 300 mm)	0.0012 (30)
Screw Lead Backlash	in	0.004 maximum
Ambient Conditions:		
Standard Ambient Temperature	°C	0 to 65
Extended Ambient Temperature*	°C	-30 to 65
Storage Temperature	°C	-40 to 85
IP Rating		IP65S
Vibration**		3.5 grms; 5 to 520 hz

* Consult Exlar for extended temperature operations

** Resolver feedback

Ratings at 25°C, operation over 25°C requires de-rating.

Product Features

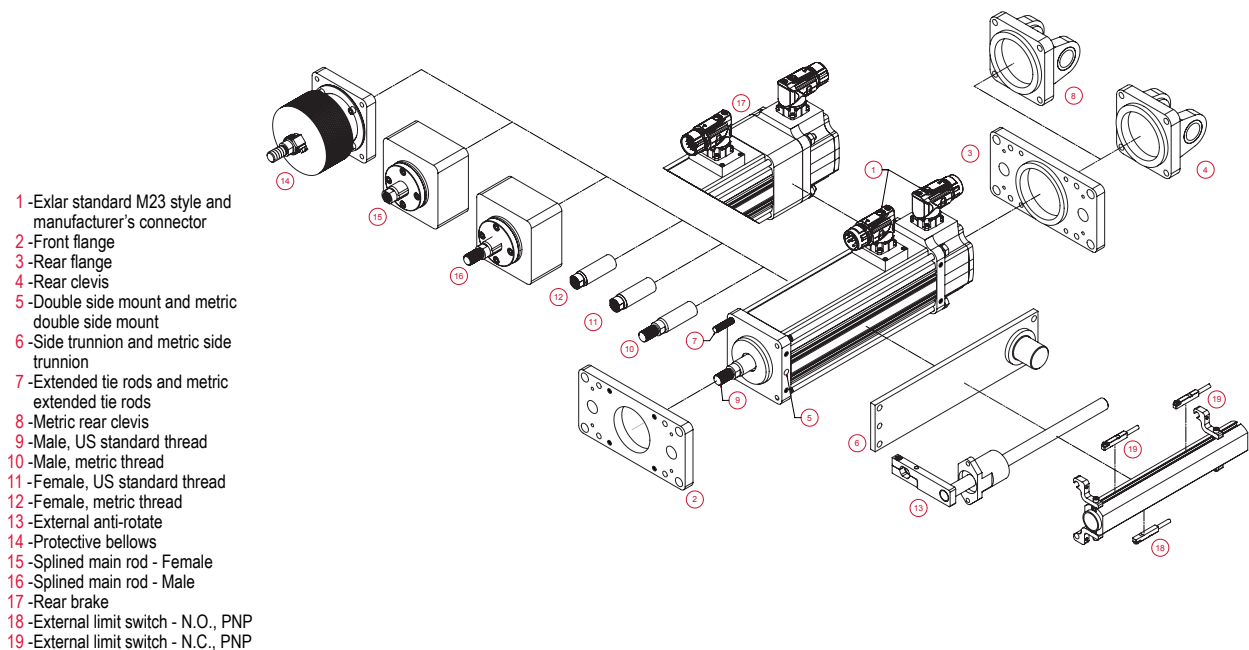
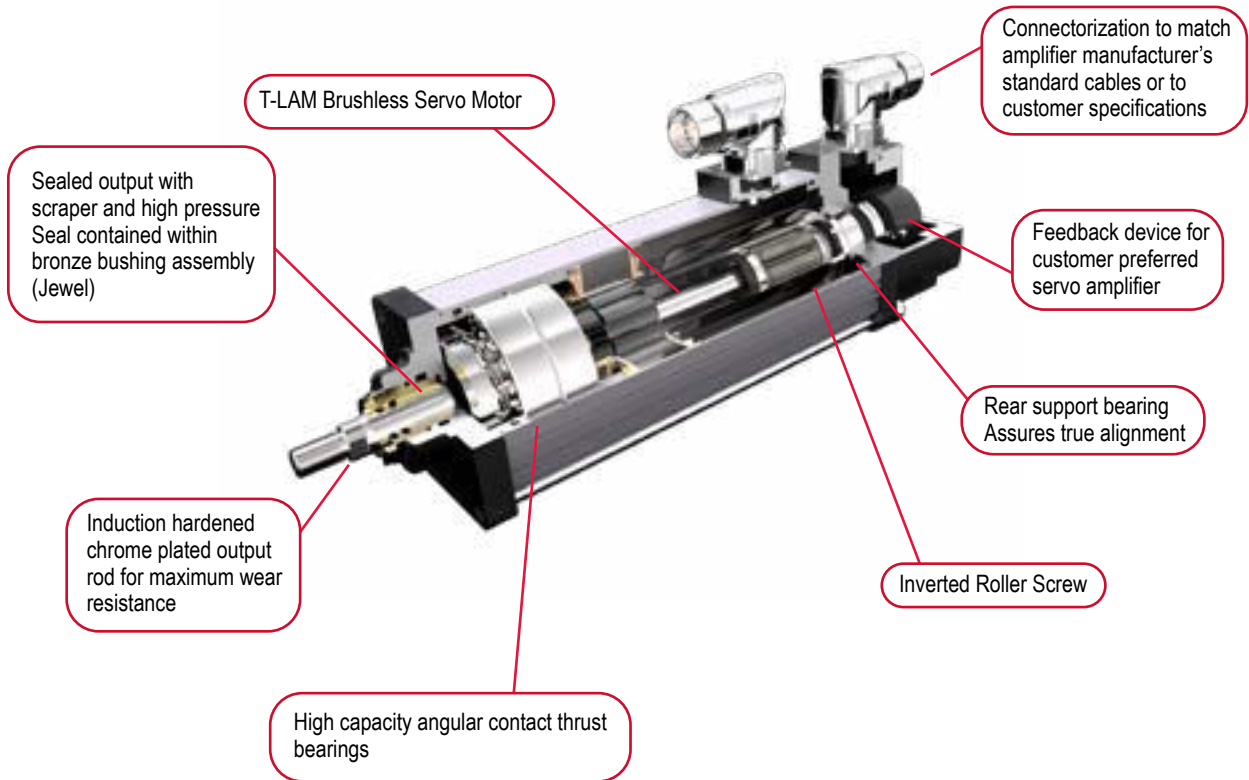

GSX Series Integrated Motor/Actuator

Industries and Applications:

Hydraulic cylinder replacement
Ball screw replacement
Pneumatic cylinder replacement

Automotive

Dispensing
Welding
Pressing
Riveting / Fastening / Joining

Food Processing

Sealing
Dispensing
Forming
Pick and Place Systems
Fillers
Cutting / Slicing / Cubing

Sawmill/Forestry

Saw Positioning
Fence Positioning
Ventilation Control Systems

Machining

Material Cutting
Broaching
Metal Forming
Tube Bending
Stamping

Entertainment / Simulation

Animatronics
Training Simulators
Ride Automation

Medical Equipment

Volumetric Pumps
Patient Positioning

Plastics

Die Cutters
Part Eject
Core Pull
Formers

Material Handling

Nip Roll Positioning
Tension Control
Web Guidance
Wire Winding

Test

Fatigue Testing
Load Simulation Testing

Repeatable force control plus positioning accuracy extends the life of costly tools when Exlar linear actuators are used for precision applications.

Repeatable force, reliable positioning accuracy, and flexible control make GSX actuators a perfect fit for assembly presses or test stands.



[Return to Table of Contents](#)

Mechanical Specifications

GSX20

Model No. (Motor Stacks)		1 Stack			2 Stack			3 Stack	
Screw Lead Designator		01	02	04	01	02	04	02	04
Screw Lead	in	0.1	0.2	0.4	0.1	0.2	0.4	0.2	0.4
	mm	2.54	5.08	10.16	2.54	5.08	10.16	5.08	10.16
Continuous Force (Motor Limited)	lbf	367	195	103	578	307	163	409	216
	N	1632	867	459	2571	1366	723	1817	962
Max Velocity	in/sec	8.3	16.8	33.3	8.3	16.8	33.3	16.8	33.3
	mm/sec	211.7	423.3	845.8	211.7	423.3	845.8	423.3	845.8
Friction Torque (standard screw)	in-lbf	1.0			1.1			1.1	
	N-m	0.11			0.12			0.12	
Friction Torque (preloaded screw)	in-lbf	2.3			2.3			2.3	
	N-m	0.25			0.26			0.26	
Min Stroke	in	3			3			6	
	mm	76			76			152	
Max Stroke	in	12			12			12	
	mm	305			305			305	
C _a (Dynamic Load Rating)	lbf	2075	1540	1230	2075	1540	1230	1540	1230
	N	9230	6850	5471	9230	6850	5471	6850	5471
Inertia (zero stroke)	lb-in-s ²	0.0007758			0.0008600			0.0009442	
	Kg-m ²	0.00008766			0.00009717			0.0001067	
Inertia Adder (per inch of stroke)	lb-in-s ² /in				0.00004667				
	Kg-m ² /in				0.000005273				
Weight (zero stroke)	lb	4.5			5.0			5.5	
	Kg	2.04			2.27			2.49	
Weight Adder (per inch of stroke)	lb				0.5				
	Kg				0.23				

GSX30

Model No. (Motor Stacks)		1 Stack			2 Stack			3 Stack	
Screw Lead Designator		01	02	05	01	02	05	02	05
Screw Lead	in	0.1	0.2	0.5	0.1	0.2	0.5	0.2	0.5
	mm	2.54	5.08	12.7	2.54	5.08	12.7	5.08	12.7
Continuous Force (Motor Limited)	lbf	792	449	190	1277	724	306	1020	432
	N	3521	1995	845	5680	3219	1363	4537	1922
Max Velocity	in/sec	5.0	10.0	25.0	5.0	10.0	25.0	10.0	25.0
	mm/sec	127.0	254.0	635.0	127.0	254.0	635.0	254.0	635.0
Friction Torque (standard screw)	in-lbf	1.5			1.7			1.9	
	N-m	0.17			0.19			0.21	
Friction Torque (preloaded screw)	in-lbf	3.3			3.5			3.7	
	N-m	0.37			0.39			0.41	
Min Stroke	in	3			3			6	
	mm	76			76			152	
Max Stroke	in	18			18			18	
	mm	457			457			457	
C _a (Dynamic Load Rating)	lbf	5516	5800	4900	5516	5800	4900	5800	4900
	N	24536	25798	21795	24536	25798	21795	25798	21795
Inertia (zero stroke)	lb-in-s ²	0.002655			0.002829			0.003003	
	Kg-m ²	0.0003000			0.0003196			0.00033963	
Inertia Adder (per inch of stroke)	lb-in-s ² /in				0.0001424				
	Kg-m ² /in				0.00001609				
Weight (zero stroke)	lb	6.5			7.65			8.8	
	Kg	2.95			3.47			3.99	
Weight Adder (per inch of stroke)	lb				1.1				
	Kg				0.50				

*See definitions on page 9

GSX Series Integrated Motor/Actuator

GSX40

Model No. (Motor Stacks)		1 Stack				2 Stack				3 Stack			
Screw Lead Designator		01	02	05	08	01	02	05	08	02	05	08	
Screw Lead	in	0.1	0.2	0.5	0.75	0.1	0.2	0.5	0.75	0.2	0.5	0.75	
	mm	2.54	5.08	12.7	19.05	2.54	5.08	12.7	19.05	5.08	12.7	19.05	
Continuous Force (Motor Limited)	lbf	2089	1194	537	358	3457	1975	889	593	2687	1209	806	
	N	9293	5310	2390	1593	15377	8787	3954	2636	11950	5378	3585	
Max Velocity	in/sec	5.0	10.0	25.0	37.5	5.0	10.0	25.0	37.5	10.0	25.0	37.5	
	mm/sec	127.0	254.0	635.0	953.0	127.0	254.0	635.0	953.0	254.0	635.0	953.0	
Friction Torque (standard screw)	in-lbf	2.7				3.0				3.5			
	N-m	0.31				0.34				0.40			
Friction Torque (preloaded screw)	in-lbf	7.2				7.5				8.0			
	N-m	0.82				0.85				0.91			
Min Stroke	in	4				6				8			
	mm	102				152				203			
Max Stroke	in	18			12	18			12	18			12
	mm	457			305	457			305	457			305
C _s (Dynamic Load Rating)	lbf	7900	8300	7030	6335	7900	8300	7030	6335	8300	7030	6335	
	N	35141	36920	31271	28179	35141	36920	31271	28179	36920	31271	28179	
Inertia (zero stroke)	lb-in-s ²	0.01132				0.01232				0.01332			
	Kg-m ²	0.0012790				0.001392				0.001505			
Inertia Adder (per inch of stroke)	lb-in-s ² /in					0.0005640							
	Kg-m ² /in					0.00006372							
Weight (zero stroke)	lb	8.0				11.3				14.6			
	Kg	3.63				5.13				6.62			
Weight Adder (per inch of stroke)	lb					2.0							
	Kg					0.91							

GSX50

Model No. (Motor Stacks)		1 Stack				2 Stack				3 Stack			
Screw Lead Designator		01	02	05	10	01	02	05	10	02	05	10	
Screw Lead	in	0.1	0.2	0.5	1.0	0.1	0.2	0.5	1.0	0.2	0.5	1.0	
	mm	2.54	5.08	12.7	25.4	2.54	5.08	12.7	25.4	5.08	12.7	25.4	
Continuous Force (Motor Limited)	lbf	4399	2578	1237	619	7150	4189	2011	1005	5598	2687	1344	
	N	19568	11466	5503	2752	31802	18634	8944	4472	24901	11953	5976	
Max Velocity	in/sec	4.0	8.0	20.0	40.0	4.0	8.0	20.0	40.0	8.0	20.0	40.0	
	mm/sec	101.6	203.0	508.0	1016.0	101.6	203.0	508.0	1016.0	203.0	508.0	1016.0	
Friction Torque (standard screw)	in-lbf	4.1				4.6				5.3			
	N-m	0.46				0.53				0.60			
Friction Torque (preloaded screw)	in-lbf	10.1				10.6				11.3			
	N-m	1.14				1.21				1.36			
Min Stroke	in	6				6				10			
	mm	152				152				254			
Max Stroke	in	10	14		10	10	14		10	14		10	
	mm	254	356		254	254	356		254	356		254	
C _s (Dynamic Load Rating)	lbf	15693	13197	11656	6363	15693	13197	11656	6363	13197	11656	6363	
	N	69806	58703	51848	28304	69806	58703	51848	28304	58703	51848	28304	
Inertia (zero stroke)	lb-in-s ²	0.02084				0.02300				0.02517			
	Kg-m ²	0.002356				0.002599				0.002844			
Inertia Adder (per inch of stroke)	lb-in-s ² /in					0.001208							
	Kg-m ² /in					0.0001365							
Weight (zero stroke)	lb	46.0				53.0				60.0			
	Kg	20.87				24.04				27.2			
Weight Adder (per inch of stroke)	lb					3.0							
	Kg					1.36							

*See definitions on page 9

GSX60

Model No. (Motor Stacks)		1 Stack			2 Stack			3 Stack		
Screw Lead Designator		03	05	10	03	05	10	03	05	10
Screw Lead	in	0.25	0.5	1.0	0.25	0.5	1	0.25	0.5	1
	mm	6.35	12.7	25.4	6.35	12.7	25.4	6.35	12.7	25.4
Continuous Force (Motor Limited)	lbf	4937	2797	1481	8058	4566	2417	11528	6533	3459
	N	21958	12443	6588	35843	20311	10753	51278	29058	15383
Max Velocity	in/sec	10.0	20.0	40.0	10.0	20.0	40.0	10.0	20.0	40.0
	mm/sec	254.0	508.0	1016.0	254.0	508.0	1016.0	254.0	508.0	1016.0
Friction Torque (standard screw)	in-lbf		8.1			10.8			14.5	
	N-m		0.91			1.22			1.64	
Friction Torque (preloaded screw)	in-lbf		14.1			16.8			20.5	
	N-m		1.59			1.90			2.32	
Min Stroke	in		6			10			10	
	mm		152			254			254	
Max Stroke	in		10			10			10	
	mm		254			254			254	
C _a (Dynamic Load Rating)	lbf	25300	22800	21200	25300	22800	21200	25300	22800	21200
	N	112540	101420	94302	112540	101420	94302	112540	101420	94302
Inertia (zero stroke)	lb-in-s ²		0.0804			0.1114			0.1424	
	Kg-m ²		0.009087			0.01259			0.01609	
Inertia Adder (per inch of stroke)	lb-in-s ² /in					0.005190				
	Kg-m ² /in					0.0005864				
Weight (zero stroke)	lb		48			62			76	
	Kg		21.77			28.12			34.47	
Weight Adder (per inch of stroke)	lb					8.0				
	Kg					3.63				

DEFINITIONS:

Continuous Force: The linear force produced by the actuator at continuous motor torque.

Max Velocity: The linear velocity that the actuator will achieve at rated motor rpm.

Friction Torque (standard screw): Amount of torque required to move the actuator when not coupled to a load.

Friction Torque (preloaded screw): Amount of torque required to move the actuator when not coupled to a load.

Min Stroke: Shortest available stroke length.

Max Stroke: Longest available stroke length.

C_a (Dynamic Load Rating): A design constant used when calculating the estimated travel life of the roller screw.

Inertia (zero stroke): Base inertia of an actuator with zero available stroke length.

Inertia Adder (per inch of stroke): Inertia per inch of stroke that must be added to the base (zero stroke) inertia to determine the total actuator inertia.

Weight (zero stroke): Base weight of an actuator with zero available stroke length.

Weight Adder (per inch of stroke): Weight adder per inch of stroke that must be added to the base (zero stroke) weight to determine the total actuator weight.

GSX Series Integrated Motor/Actuator

Weight Adders of GSX Accessories

Weight Adders of GSX Accessories	GSX20		GSX30		GSX40		GSX50		GSX60	
	lbs	kg	lbs	kg	lbs	kg	lbs	kg	lbs	kg
Front Flange Mount	0.7	0.3	1.7	0.8	4.0	1.8	10.8	4.9	15.2	6.9
Rear Flange Mount	1.0	0.5	1.8	0.8	5.0	2.3	12.8	5.8	30.4	13.7
Side Mount	0.0	0.0	0.0	0.0	0.0	0.0	0.0	0.0	0.0	0.0
Extended Tie Rod	0.0	0.0	0.1	0.0	0.2	0.1	0.3	0.2	0.5	0.2
Side Trunnion	0.8	0.3	0.8	0.3	1.8	0.8	4.6	2.1	9.3	4.2
3 inch Stroke	2.2	1.0	2.8	1.3	NA	NA	NA	NA	NA	NA
4 inch Stroke	NA	NA	NA	NA	5.1	2.3	NA	NA	NA	NA
6 inch Stroke	3.1	1.4	3.6	1.6	5.9	2.7	14.3	6.5	26.6	12.1
8 inch Stroke	NA	NA	NA	NA	6.7	3.0	NA	NA	NA	NA
10 inch Stroke	3.9	1.8	5.0	2.3	7.5	3.4	17.7	8.0	32.3	14.7
12 inch Stroke	4.4	2.0	5.7	2.6	8.2	3.8	NA	NA	NA	NA
14 inch Stroke	NA	NA	6.9	3.1	NA	NA	21.1	9.6	NA	NA
18 inch Stroke	NA	NA	7.6	3.5	10.6	4.8	NA	NA	NA	NA
Rear Clevis Mount w/ Pin	0.4	0.2	1.1	0.5	1.9	0.8	5.1	2.3	13.6	6.2
Anti-Rotation (incl. flange)	1.1	0.5	2.6	1.2	5.3	2.4	6.6	3.0	21.0	10.0
External Limit Switch (incl. AR)	1.2	0.5	2.8	1.2	5.6	2.5	6.9	3.1	21.4	9.7
3 inch Stroke	1.4	0.6	3.0	1.4	NA	NA	NA	NA	NA	NA
6 inch Stroke	1.5	0.7	3.2	1.5	6.0	2.7	7.8	3.5	22.2	10.1
8 inch Stroke	NA	NA	NA	NA	6.1	2.8	NA	NA	NA	NA
10 inch Stroke	1.6	0.7	3.5	1.6	6.3	2.8	8.1	3.7	22.4	10.2
12 inch Stroke	1.7	0.8	3.6	1.6	6.4	2.9	NA	NA	NA	NA
14 inch Stroke	NA	NA	3.7	1.7	NA	NA	8.5	3.9	NA	NA
18 inch Stroke	NA	NA	3.9	1.8	6.7	3.1	NA	NA	NA	NA
Splined Main Rod	0.3	0.1	1.0	0.5	2.2	1.0	4.8	2.2	14.8	6.7
Protective Bellows	0.2	0.1	0.3	0.1	0.3	0.2	0.4	0.2	0.9	0.4
Rod Clevis	0.2	0.1	0.5	0.2	1.4	0.6	3.5	1.6	8.2	3.7
Spherical Rod Eye	0.2	0.1	0.2	0.1	0.7	0.3	1.6	0.7	NA	NA
Rod Eye	0.2	0.1	0.3	0.2	1.2	0.5				

*All weights are approximate

Electrical Specifications

GSX20

Motor Stator		118	138	158	168	218	238	258	268	318*	338*	358*	368*
Bus Voltage	Vrms	115	230	400	460	115	230	400	460	115	230	400	460
Speed @ Bus Voltage	rpm	5000											
RMS SINUSOIDAL COMMUTATION													
Continuous Motor Torque	lbf-in	7.6	7.3	7.0	7.0	11.9	11.5	11.0	11.3	15.0	15.3	14.6	14.9
	Nm	0.86	0.83	0.79	0.79	1.34	1.30	1.25	1.28	1.70	1.73	1.65	1.69
Torque Constant (Kt) (+/- 10% @ 25°C)	lbf-in/A	2.5	5.2	7.5	9.5	2.5	5.2	8.6	10.1	2.5	5.3	8.8	10.1
	Nm/A	0.28	0.59	0.85	1.07	0.28	0.59	0.97	1.15	0.29	0.59	0.99	1.15
Continuous Current Rating	(Greased) A	3.4	1.6	1.0	0.8	5.4	2.5	1.4	1.2	6.6	3.2	1.9	1.6
	(Oil Cooled) A	6.9	3.1	2.1	1.6	10.8	4.9	2.9	2.5	13.2	6.5	3.7	3.3
Peak Current Rating	A	6.9	3.1	2.1	1.6	10.8	4.9	2.9	2.5	13.2	6.5	3.7	3.3
O-PK SINUSOIDAL COMMUTATION													
Continuous Motor Torque	lbf-in	7.6	7.3	7.0	7.0	11.9	11.5	11.0	11.3	15.0	15.3	14.6	14.9
	Nm	0.86	0.83	0.79	0.79	1.34	1.30	1.25	1.28	1.70	1.73	1.65	1.69
Torque Constant (Kt) (+/- 10% @ 25°C)	lbf-in/A	1.7	3.7	5.3	6.7	1.7	3.7	6.1	7.2	1.8	3.7	6.2	7.2
	Nm/A	0.20	0.42	0.60	0.76	0.20	0.42	0.69	0.81	0.20	0.42	0.70	0.81
Continuous Current Rating	(Greased) A	4.9	2.2	1.5	1.2	7.6	3.5	2.0	1.8	9.4	4.6	2.6	2.3
	(Oil Cooled) A	9.7	4.5	2.9	2.3	15.2	7.0	4.1	3.5	18.7	9.2	5.3	4.7
Peak Current Rating	A	9.7	4.5	2.9	2.3	15.2	7.0	4.1	3.5	18.7	9.2	5.3	4.7
MOTOR STATOR DATA													
Voltage Constant (Ke) (+/- 10% @ 25°C)	Vrms/Krpm	16.9	35.5	51.5	64.8	16.9	35.5	58.6	69.3	17.3	36.0	59.9	69.3
	Vpk/Krpm	23.9	50.2	72.8	91.7	23.9	50.2	82.9	98.0	24.5	50.9	84.8	98.0
Pole Configuration		8	8	8	8	8	8	8	8	8	8	8	8
Resistance (L-L)(+/- 5% @ 25°C)	Ohms	2.6	12.5	28.8	45.8	1.1	5.3	15.5	20.7	0.76	3.1	9.6	12.2
Inductance (L-L)(+/- 15%)	mH	4.6	21.4	47.9	68.3	2.5	10.2	28.3	39.5	1.7	7.4	18.5	27.4
Brake Inertia	lbf-in-sec ²	0.00012											
	Kg-cm ²	0.135											
Brake Current @ 24 VDC	A	0.33											
Brake Holding Torque (Min)	lbf-in	22											
	Nm	2.5											
Brake Engage/Disengage Time	ms	14/28											
Mechanical Time Constant (tm), ms	min	4.7	5.1	5.5	5.6	2.0	2.1	2.3	2.2	1.3	1.2	1.4	1.3
	max	6.6	7.2	7.9	7.9	2.8	3.0	3.3	3.1	1.8	1.8	1.9	1.8
Electrical Time Constant (te)	ms	1.8	1.7	1.7	1.5	2.2	1.9	1.8	1.9	2.3	2.4	1.9	2.2
Insulation Class		180 (H)											

For amplifiers using peak sinusoidal ratings, multiply RMS sinusoidal Kt by 0.707 and current by 1.414.
 *Refer to performance specifications on page 7 for availability of 3 stack stator by stroke/lead combination.
 Test data derived using NEMA recommended aluminum heatsink 10" x 10" x 1/4" at 25°C ambient.

Specifications subject to change without notice.

GSX Series Integrated Motor/Actuator

GSX30

Motor Stator		118	138	158	168	218	238	258	268	318*	338*	358*	368*
Bus Voltage	Vrms	115	230	400	460	115	230	400	460	115	230	400	460
Speed @ Bus Voltage	rpm	3000											
RMS SINUSOIDAL COMMUTATION													
Continuous Motor Torque	lbf-in	16.9	16.8	16.3	16.0	26.9	27.1	26.7	27.0	38.7	38.2	36.2	36.3
	Nm	1.91	1.90	1.84	1.81	3.04	3.06	3.01	3.05	4.37	4.32	4.09	4.10
Torque Constant (Kt) (+/- 10% @ 25°C)	lbf-in/A	4.4	8.7	15.5	17.5	4.4	8.7	15.5	17.5	4.4	8.7	15.6	17.5
	Nm/A	0.49	0.99	1.75	1.97	0.49	0.99	1.75	1.97	0.50	0.98	1.77	1.98
Continuous Current Rating	(Greased) A	4.3	2.2	1.2	1.0	6.9	3.5	1.9	1.7	9.7	4.9	2.6	2.3
	(Oil Cooled) A	8.6	4.3	2.4	2.0	13.8	6.9	3.8	3.4	19.5	9.9	5.2	4.6
Peak Current Rating	A	8.6	4.3	2.4	2.0	13.8	6.9	3.8	3.4	19.5	9.9	5.2	4.6
O-PK SINUSOIDAL COMMUTATION													
Continuous Motor Torque	lbf-in	16.9	16.8	16.3	16.0	26.9	27.1	26.7	27.0	38.7	38.2	36.2	36.3
	Nm	1.91	1.90	1.84	1.81	3.04	3.06	3.01	3.05	4.37	4.32	4.09	4.10
Torque Constant (Kt) (+/- 10% @ 25°C)	lbf-in/A	3.1	6.2	11.0	12.4	3.1	6.2	11.0	12.4	3.1	6.1	11.1	12.4
	Nm/A	0.35	0.70	1.24	1.40	0.35	0.70	1.24	1.40	0.35	0.69	1.25	1.40
Continuous Current Rating:	(Greased) A	6.1	3.0	1.7	1.4	9.7	4.9	2.7	2.4	13.8	7.0	3.7	3.3
	(Oil Cooled) A	12.2	6.1	3.3	2.9	19.5	9.8	5.4	4.9	27.6	13.9	7.3	6.5
Peak Current Rating	A	12.2	6.1	3.3	2.9	19.5	9.8	5.4	4.9	27.6	13.9	7.3	6.5
MOTOR STATOR DATA													
Voltage Constant (Ke) (+/- 10% @ 25°C)	Vrms/Krpm	29.8	59.7	105.8	119.3	29.8	59.7	105.8	119.3	30.3	59.2	106.8	119.8
	Vpk/Krpm	42.2	84.4	149.7	168.7	42.2	84.4	149.7	168.7	42.9	83.7	151.0	169.4
Pole Configuration		8	8	8	8	8	8	8	8	8	8	8	8
Resistance (L-L)(+/- 5% @ 25°C)	Ohms	2.7	10.8	36.3	47.9	1.1	4.4	14.1	17.6	0.65	2.6	9.3	11.6
Inductance (L-L)(+/- 15%)	mH	7.7	30.7	96.8	123.0	3.7	14.7	46.2	58.7	2.5	9.5	30.9	38.8
Brake Inertia	lbf-in-sec ²	0.00033											
	Kg-cm ²	0.38											
Brake Current @ 24 VDC	A	0.5											
Brake Holding Torque (Min)	lbf-in	40											
	Nm	4.5											
Brake Engage/Disengage Time	ms	19/29											
Mechanical Time Constant (tm), ms	min	4.9	4.9	5.2	5.4	2.0	2.0	2.0	2.0	1.1	1.2	1.3	1.3
	max	9.4	9.5	10.1	10.5	3.9	3.8	3.9	3.8	2.2	2.3	2.5	2.5
Electrical Time Constant (te)	ms	2.9	2.8	2.7	2.6	3.3	3.4	3.3	3.3	3.8	3.7	3.3	3.3
Insulation Class		180 (H)											

For amplifiers using peak sinusoidal ratings, multiply RMS sinusoidal Kt by 0.707 and current by 1.414.
 *Refer to performance specifications on page 7 for availability of 3 stack stator by stroke/lead combination.
 Test data derived using NEMA recommended aluminum heatsink 10" x 10" x 3/8" at 25°C ambient.

Specifications subject to change without notice.

GSX Series Integrated Motor/Actuator

GSX40

Motor Stator		118	138	158	168	218	238	258	268	338*	358*	368*
Bus Voltage	Vrms	115	230	400	460	115	230	400	460	230	400	460
Speed @ Bus Voltage	rpm	3000										
RMS SINUSOIDAL COMMUTATION												
Continuous Motor Torque	lbf-in	47.5	47.5	45.9	45.4	75.1	78.6	78.7	79.5	106.9	105.3	106.9
	Nm	5.37	5.36	5.19	5.13	8.49	8.89	8.89	8.99	12.08	11.90	12.08
Torque Constant (Kt) (+/- 10% @ 25°C)	lbf-in/A	4.1	8.2	14.5	16.8	4.1	8.2	14.5	16.8	8.4	14.5	16.8
	Nm/A	0.46	0.93	1.64	1.90	0.46	0.93	1.64	1.90	0.95	1.64	1.90
Continuous Current Rating	(Greased) A	12.9	6.5	3.5	3.0	20.5	10.7	6.0	5.3	14.2	8.1	7.1
	(Oil Cooled) A	25.9	12.9	7.1	6.0	40.9	21.4	12.1	10.6	28.5	16.2	14.2
Peak Current Rating	A	25.9	12.9	7.1	6.0	40.9	21.4	12.1	10.6	28.5	16.2	14.2
O-PK SINUSOIDAL COMMUTATION												
Continuous Motor Torque	lbf-in	47.5	47.5	45.9	45.4	75.1	78.6	78.7	79.5	106.9	105.3	106.9
	Nm	5.37	5.36	5.19	5.13	8.49	8.89	8.89	8.99	12.08	11.90	12.08
Torque Constant (Kt) (+/- 10% @ 25°C)	lbf-in/A	2.9	5.8	10.3	11.9	2.9	5.8	10.3	11.9	5.9	10.3	11.9
	Nm/A	0.33	0.66	1.16	1.34	0.33	0.66	1.16	1.34	0.67	1.16	1.34
Continuous Current Rating	(Greased) A	18.3	9.1	5.0	4.3	28.9	15.1	8.5	7.5	20.1	11.4	10.1
	(Oil Cooled) A	36.6	18.3	10.0	8.6	57.9	30.3	17.1	15.0	40.3	22.9	20.1
Peak Current Rating	A	36.6	18.3	10.0	8.6	57.9	30.3	17.1	15.0	40.3	22.9	20.1
MOTOR STATOR DATA												
Voltage Constant (Ke) (+/- 10% @ 25°C)	Vrms/Krpm	28.0	56.0	99.3	114.6	28.0	56.0	99.3	114.6	57.3	99.3	114.6
	Vpk/Krpm	39.6	79.2	140.5	162.1	39.6	79.2	140.5	162.1	81.0	140.5	162.1
Pole Configuration		8	8	8	8	8	8	8	8	8	8	8
Resistance (L-L)(+/- 5% @ 25°C)	Ohms	0.42	1.7	5.7	7.8	0.2	0.72	2.26	3.0	0.5	1.52	2.0
Inductance (L-L)(+/- 15%)	mH	3.0	11.9	37.5	49.9	1.2	5.4	18.2	23.1	4.0	12.0	16.0
Brake Inertia	lbf-in-sec ²	0.00096										
	Kg-cm ²	1.08										
Brake Current @ 24 VDC	A	0.67										
Brake Holding Torque (Min)	lbf-in	97										
	Nm	11										
Brake Engage/Disengage Time	ms	20/29										
Mechanical Time Constant (tm), ms	min	4.5	4.5	4.8	4.9	2.1	1.9	1.9	1.9	1.2	1.3	1.2
	max	6.0	6.0	6.4	6.6	2.8	2.6	2.6	2.5	1.7	1.7	1.7
Electrical Time Constant (te)	ms	7.0	7.0	6.6	6.4	5.9	7.5	8.0	7.8	8.2	7.9	8.2
Insulation Class		180 (H)										

*Refer to performance specifications on page 8 for availability of 3 stack stator by stroke/lead combination.
Test data derived using NEMA recommended aluminum heatsink 12" x 12" x 1/2" at 25°C ambient.

Specifications subject to change without notice.

GSX Series Integrated Motor/Actuator

GSX50

Motor Stator		138	158	168	238	258	268	338	358	368
Bus Voltage	Vrms	230	400	460	230	400	460	230	400	460
Speed @ Bus Voltage	rpm	2400								
RMS SINUSOIDAL COMMUTATION										
Continuous Motor Torque	lbf-in	107.2	104.8	109.4	179.9	178.8	177.8	233.3	237.2	238.3
	Nm	12.12	11.84	12.36	20.32	20.20	20.09	26.36	26.80	26.93
Torque Constant (Kt) (+/- 10% @ 25°C)	lbf-in/A	11.8	20.2	23.6	11.8	20.2	23.6	12.0	20.2	24.0
	Nm/A	1.33	2.28	2.67	1.33	2.28	2.67	1.36	2.28	2.71
Continuous Current Rating	(Greased) A	10.2	5.8	5.2	17.0	9.9	8.4	21.7	13.1	11.1
	(Oil Cooled) A	20.3	11.6	10.4	34.1	19.8	16.8	43.4	26.2	22.2
Peak Current Rating	A	20.3	11.6	10.4	34.1	19.8	16.8	43.4	26.2	22.2
O-PK SINUSOIDAL COMMUTATION										
Continuous Motor Torque	lbf-in	107.2	104.8	109.4	179.9	178.8	177.8	233.3	237.2	238.3
	Nm	12.12	11.84	12.36	20.32	20.20	20.09	26.36	26.80	26.93
Torque Constant (Kt) (+/- 10% @ 25°C)	lbf-in/A	8.3	14.3	16.7	8.3	14.3	16.7	8.5	14.3	17.0
	Nm/A	0.94	1.62	1.88	0.94	1.62	1.88	0.96	1.62	1.92
Continuous Current Rating	(Greased) A	14.4	8.2	7.3	24.1	14.0	11.9	30.7	18.5	15.7
	(Oil Cooled) A	28.7	216.4	14.7	48.2	27.9	23.8	61.4	37.1	31.4
Peak Current Rating	A	28.7	16.4	14.7	48.2	27.9	23.8	61.4	37.1	31.4
MOTOR STATOR DATA										
Voltage Constant (Ke) (+/- 10% @ 25°C)	Vrms/Krpm	80.6	138.1	161.1	80.6	138.1	161.1	82.0	138.1	164.0
	Vpk/Krpm	113.9	195.3	227.9	113.9	195.3	227.9	116.0	195.3	232.0
Pole Configuration		8	8	8	8	8	8	8	8	8
Resistance (L-L)(+/- 5% @ 25°C)	Ohms	0.87	2.68	3.34	0.34	1.01	1.39	0.22	0.61	0.86
Inductance (L-L)(+/- 15%)	mH	21.7	63.9	78.3	8.9	27.6	41.5	6.3	17.8	28.2
Brake Inertia	lbf-in-sec ²	0.0084								
	Kg-cm ²	9.5								
Brake Current @ 24 VDC	A	1								
Brake Holding Torque (Min)	lbf-in	354								
	Nm	40								
Brake Engage/Disengage Time	ms	25/73								
Mechanical Time Constant (tm), ms	min	2.2	2.3	2.1	0.9	0.9	0.9	0.5	0.5	0.5
	max	2.8	3.0	2.7	1.1	1.1	1.1	0.7	0.7	0.7
Electrical Time Constant (te)	ms	25.0	23.9	23.4	26.1	27.3	29.9	28.0	29.0	32.9
Insulation Class		180 (H)								

Test data derived using NEMA recommended aluminum heatsink 12" x 12" x 1/2" at 25°C ambient

Specifications subject to change without notice.

GSX Series Integrated Motor/Actuator

GSX60

Motor Stator		138	158	168	238	258	268	358	368
Bus Voltage	Vrms	230	400	460	230	400	460	400	460
Speed @ Bus Voltage	rpm	2400							
RMS SINUSOIDAL COMMUTATION									
Continuous Motor Torque	lbf-in	254.2	249.9	261.9	424.8	423.0	427.5	595.6	615.0
	Nm	28.72	28.23	29.59	47.99	47.79	48.30	67.29	69.49
Torque Constant (Kt) (+/- 10% @ 25°C)	lbf-in/A	12.6	21.8	25.2	12.6	21.8	25.2	21.4	25.2
	Nm/A	1.42	2.46	2.84	1.42	2.46	2.84	2.42	2.84
Continuous Current Rating	(Greased) A	22.6	12.8	11.6	37.7	21.7	19.0	31.1	27.3
	(Oil Cooled) A	45.2	25.6	23.3	75.5	43.4	38.0	62.2	54.6
Peak Current Rating	A	45.2	25.6	23.3	75.5	43.4	38.0	62.2	54.6
O-PK SINUSOIDAL COMMUTATION									
Continuous Motor Torque	lbf-in	254.2	249.9	261.9	424.8	423.0	427.5	595.6	611.6
	(Nm)	28.72	28.23	29.59	47.99	47.79	48.30	67.29	69.10
Torque Constant (Kt) (+/- 10% @ 25°C)	lbf-in/A	8.9	15.4	17.8	8.9	15.4	17.8	15.1	17.8
	Nm/A	1.01	1.74	2.01	1.01	1.74	2.01	1.71	2.01
Continuous Current Rating	(Greased) A	31.9	18.1	16.4	53.4	30.7	26.8	44.0	38.4
	(Oil Cooled) A	63.9	36.2	32.9	106.7	61.3	53.7	88.0	76.8
Peak Current Rating	A	63.9	36.2	32.9	106.7	61.3	53.7	88.0	76.8
MOTOR STATOR DATA									
Voltage Constant (Ke) (+/- 10% @ 25°C)	Vrms/Krpm	85.9	148.9	171.8	85.9	148.9	171.8	146.1	171.8
	Vpk/Krpm	121.5	210.6	243.0	121.5	210.6	243.0	206.6	243.0
Pole Configuration		8	8	8	8	8	8	8	8
Resistance (L-L)(+/- 5% @ 25°C)	Ohms	0.3	1.0	1.2	0.13	0.41	0.5	0.23	0.3
Inductance (L-L)(+/- 15%)	mH	8.3	24.8	29.4	3.9	11.8	15.8	7.5	10.3
Brake Inertia	lbf-in-sec ²	0.02815							
	Kg-cm ²	31.8							
Brake Current @ 24 VDC	A	1.45							
Brake Holding Torque (Min)	lbf-in	708							
	Nm	80							
Brake Engage/Disengage Time	ms	53/97							
Mechanical Time Constant (tm), ms	min	3.9	4.0	3.6	1.6	1.6	1.6	1.0	0.9
	max	4.3	4.5	4.1	1.8	1.8	1.8	1.1	1.0
Electrical Time Constant (te)	ms	25.4	24.6	24.0	29.4	29.1	29.8	32.1	33.8
Insulation Class		180 (H)							

Test data derived using NEMA recommended aluminum heatsink 16" x 16" x 1" at 25°C ambient
The GSX60-06 can only accommodate a single stack stator.

Specifications subject to change without notice.

GSX Series Integrated Motor/Actuator

Estimated Service Life

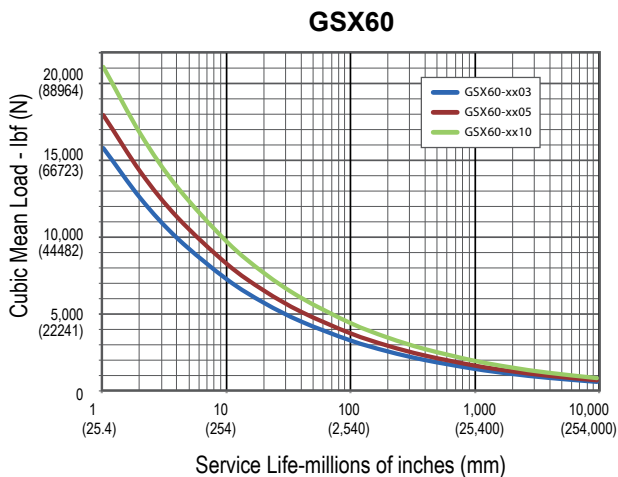
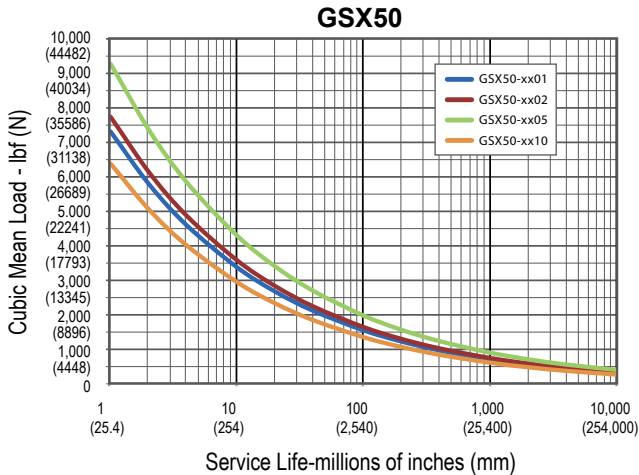
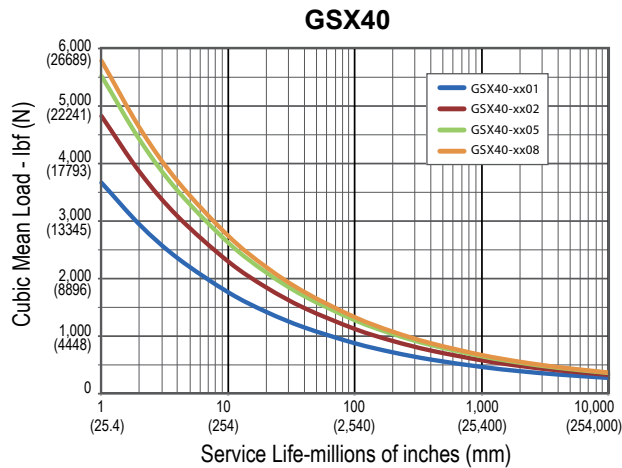
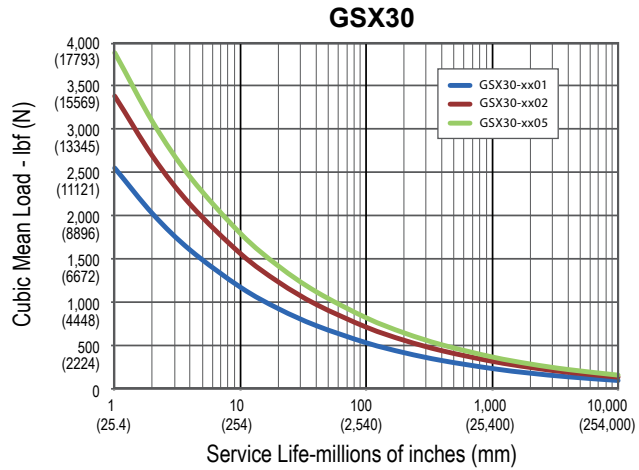
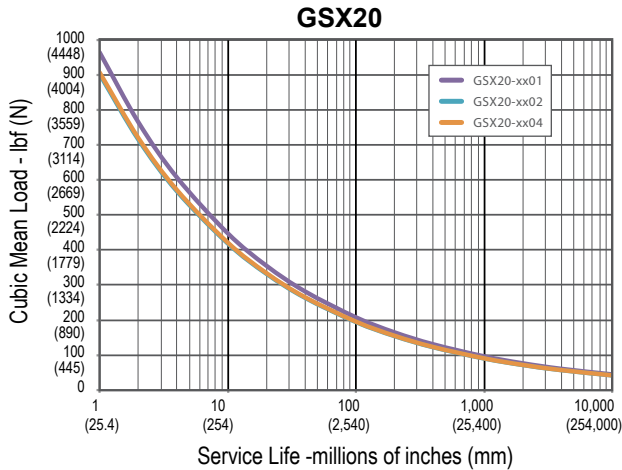

The L_{10} expected life of a roller screw linear actuator is expressed as the linear travel distance that 90% of properly maintained roller screws manufactured are expected to meet or exceed. This is not a guarantee and these charts should be used for estimation purposes only.

The underlying formula that defines this value is:
Travel life in millions of inches, where:

$$L_{10} = \left(\frac{C_a}{F_{cml}} \right)^3 \times \ell$$

C_a = Dynamic load rating (lbf)
 F_{cml} = Cubic mean applied load (lbf)
 ℓ = Roller screw lead (inches)

For additional details on calculating estimated service life, please refer to the Engineering Reference, page 169.

Service Life Estimate Assumptions:

- Sufficient quality and quantity of lubrication is maintained throughout service life (please refer to engineering reference on page 173 for lubrication interval estimates.)
- Bearing and screw temperature between 20° C and 40° C
- No mechanical hard stops (external or internal) or impact loads
- No external side loads
- Does not apply to short stroke, high frequency applications such as fatigue testing or short stroke, high force applications such as pressing. (For information on calculating estimating life for unique applications please refer to the engineering reference on page 169.)

Speed vs. Force Curves

These charts represent typical linear speed versus linear force curves for the GSX actuators using common brushless motor amplifiers. The GSX Series are compatible with many different brushless motor amplifiers; any differences in the performance

ratings of these amplifiers can alter the actuator's performance. Thus, the curves below should be used for estimation only. (Further information is available by contacting your local sales representative.)

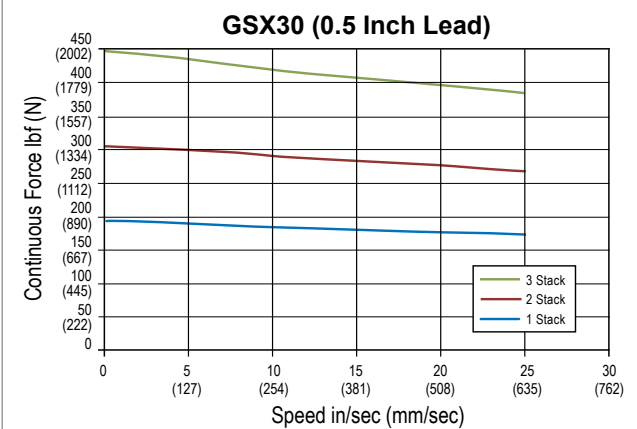
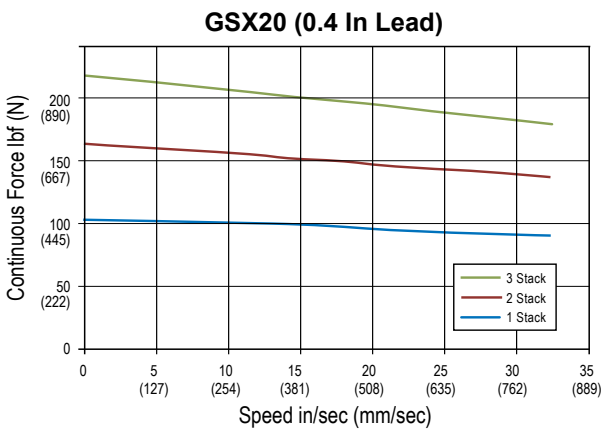
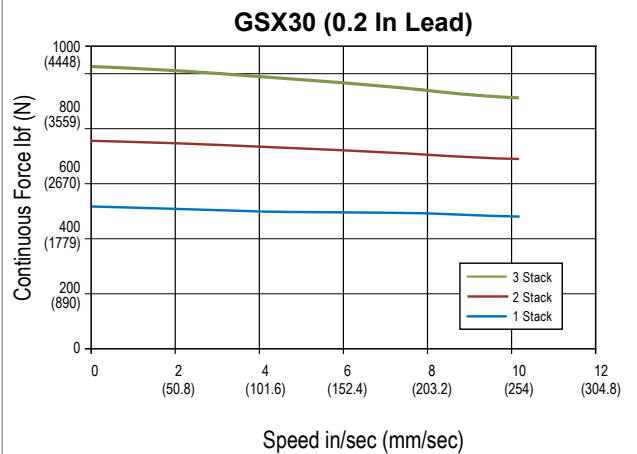
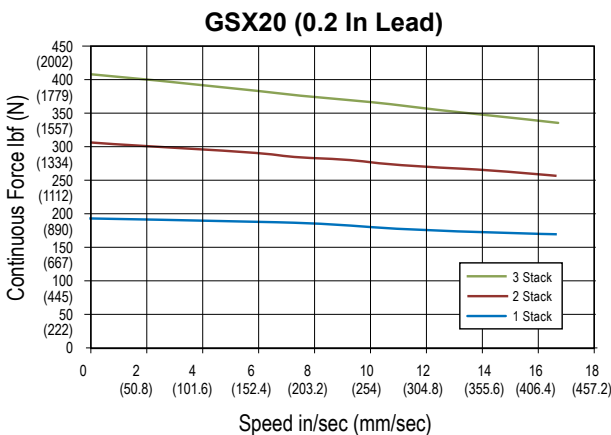
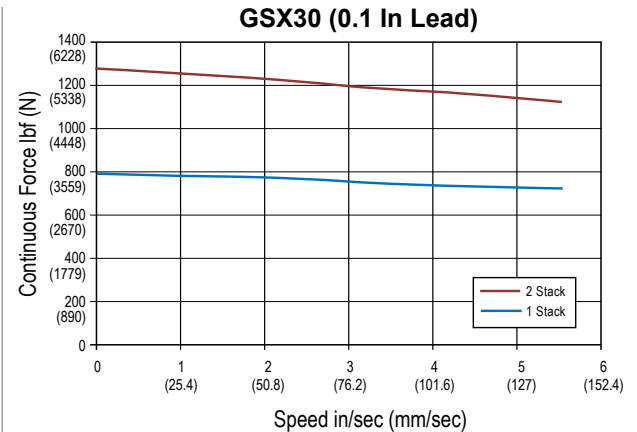
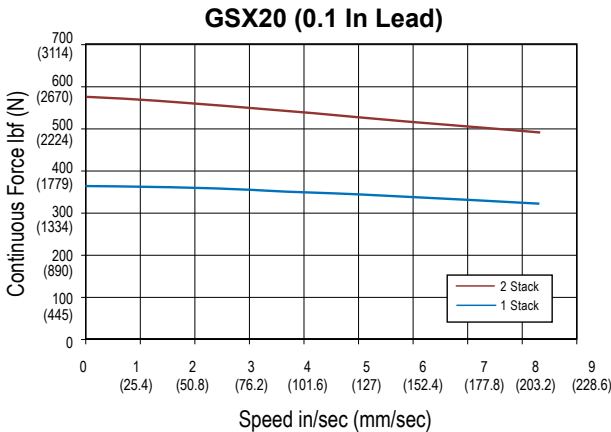

See page 22 for explanation of motor stator options (1x8, 2x8, 3x8)
See page 7 for mechanical specifications

Test data derived using NEMA recommended aluminum heatsink 10" x 10" x 1/4" for GSX20 and 10" x 10" x 3/8" for GSX30. Testing ambient temperature 25°C.

GSX Series Integrated Motor/Actuator

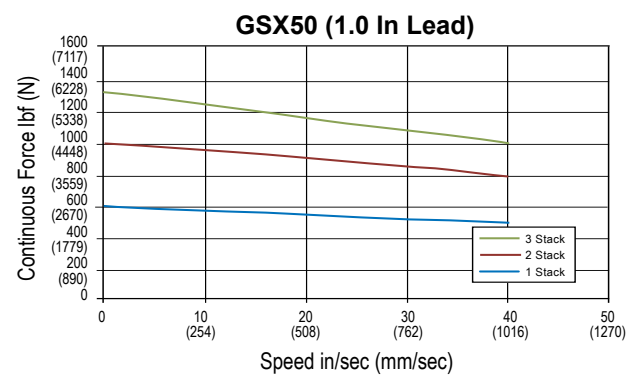
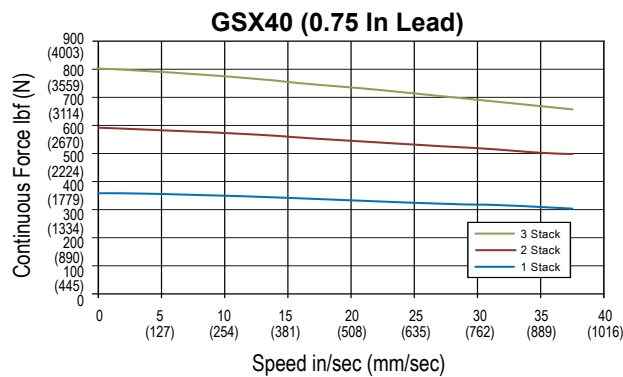
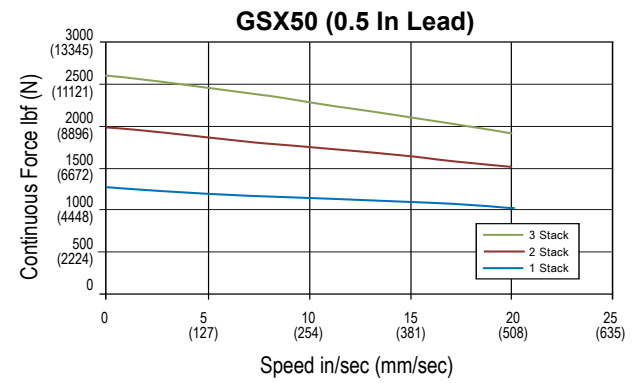
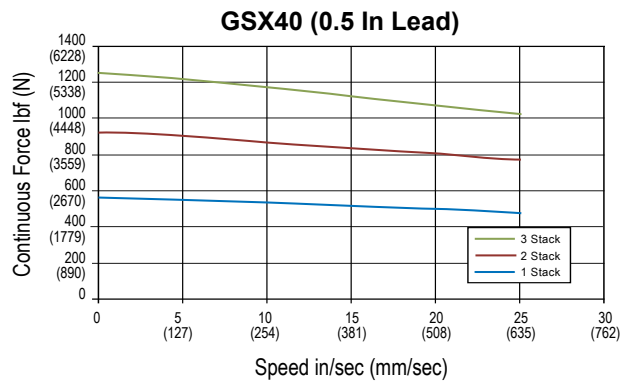
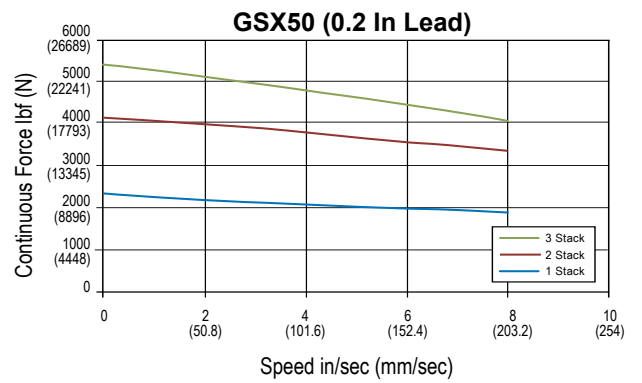
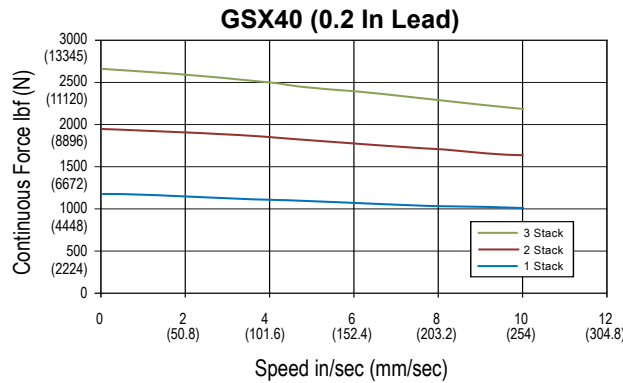
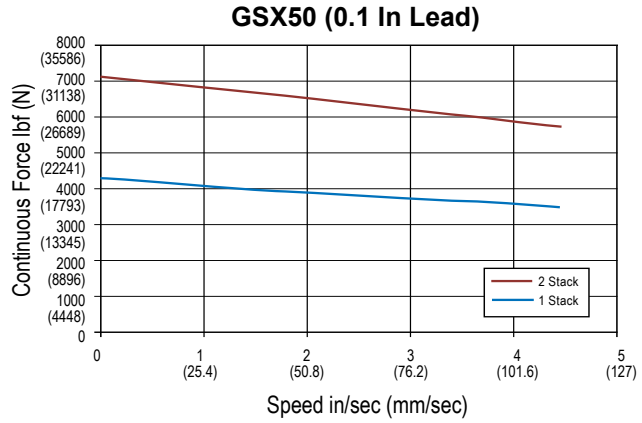
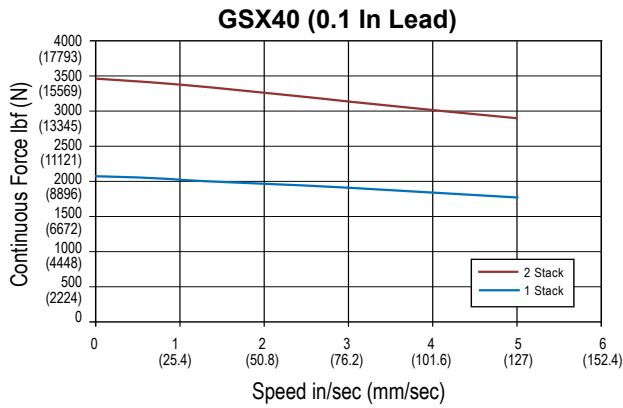

GSX Series Integrated Motor/Actuator

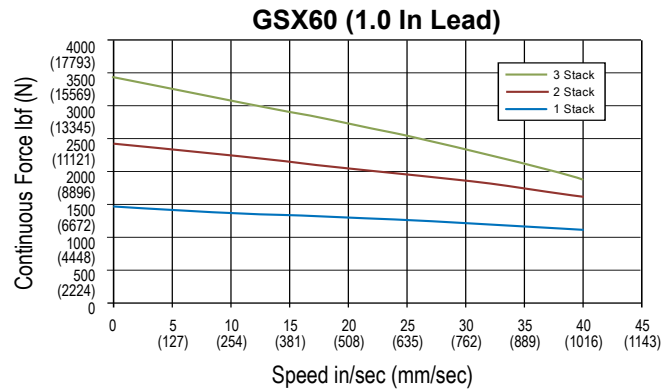
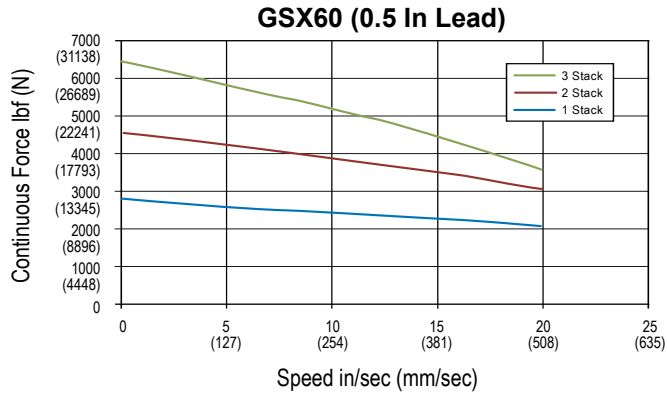
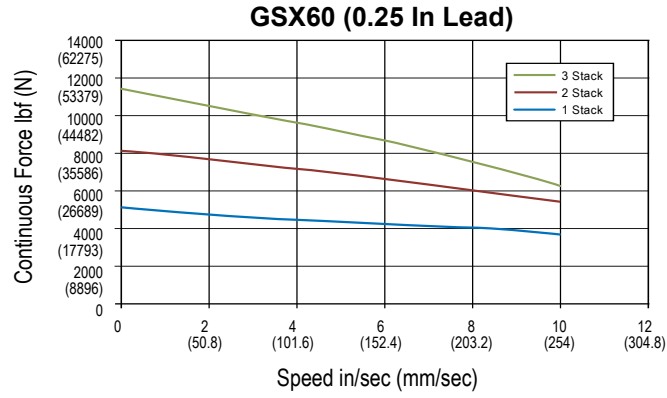

See page 22 for explanation of motor stator options (1x8, 2x8, 3x8)
See page 7 for mechanical specifications

Test data derived using NEMA recommended aluminum heatsink 12" x 12" x 1/2" for GSX40, 12" x 12" x 1/2" for GSX50, and 16" x 16" x 1" for GSX60.
Testing ambient temperature 25°C.

GSX Series Integrated Motor/Actuator

System Configuration

GSX Series actuators include an integrated brushless servo motor. The unique design gives users a variety of feedback configuration options so GSX units can be powered by almost any brushless motor amplifier on the market.

This flexibility means GSX actuators can be incorporated into today's high performance single and multi-axis motion control

systems. For food and beverage packaging, to multi-axis turning centers, to aircraft assembly, the GSX Series units offers incredible performance and durability.

The schematic below shows typical connections for a single axis system with actuator and servo amplifier.

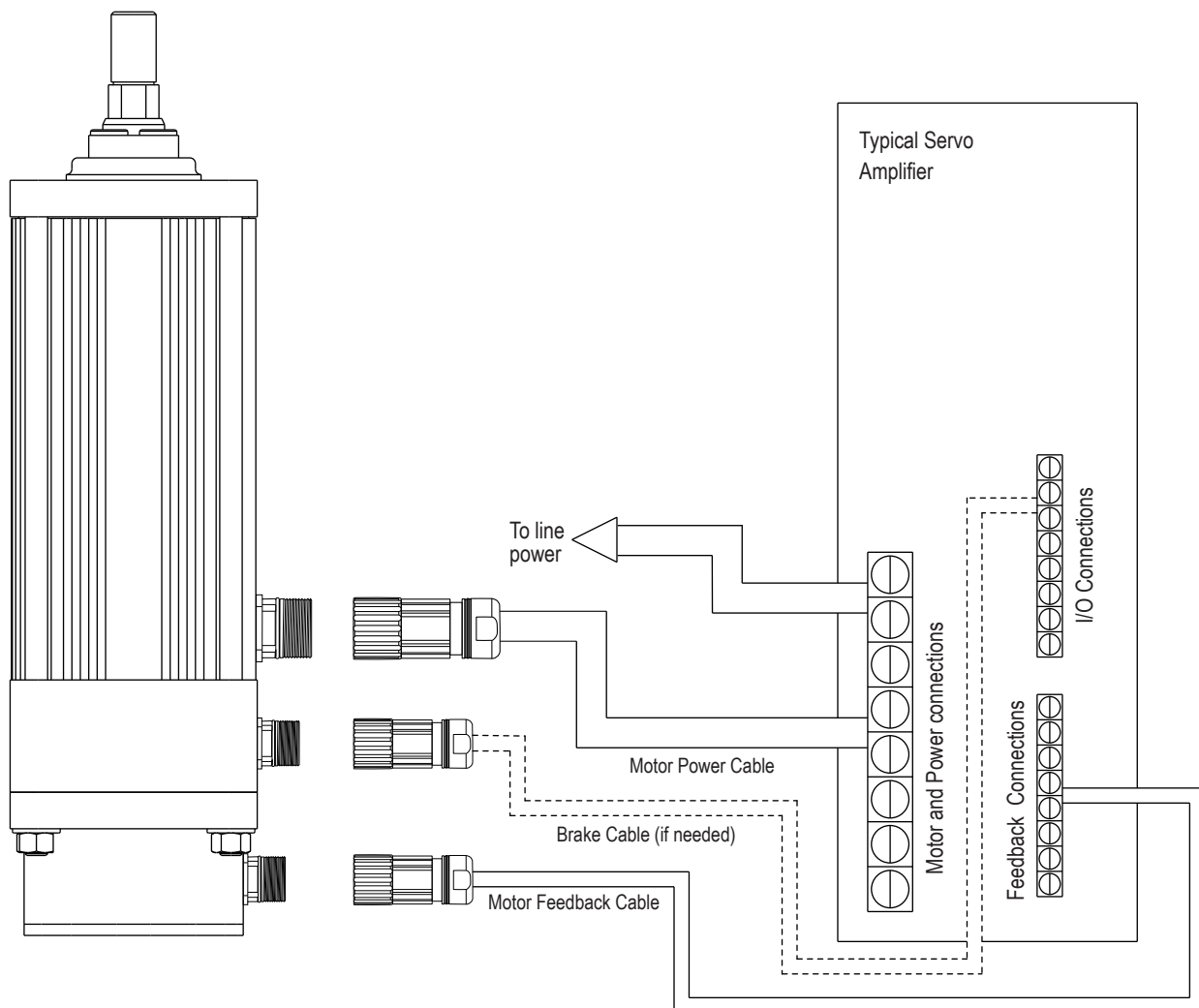

Options

AR = Anti-rotation Option

The unique design of the GSX Series of linear actuators permits the extending rod to rotate. This capability simplifies setup by allowing the user to rotate the rod in and out of the actuator for mechanical attachment or system testing.

However, this feature also requires that once setup and testing are completed, the rod be kept from rotating so proper linear motion will be maintained. In most applications the actuator's load is coupled to linear bearings, or some other support device. In these cases the load cannot rotate, so a separate anti-rotation system is not needed.

For applications in which the load is free to rotate, Exlar offers anti-rotation systems. Shorter GSX units use an anti-rotation arm on one side of the actuator. Longer strokes use arms on both sides.

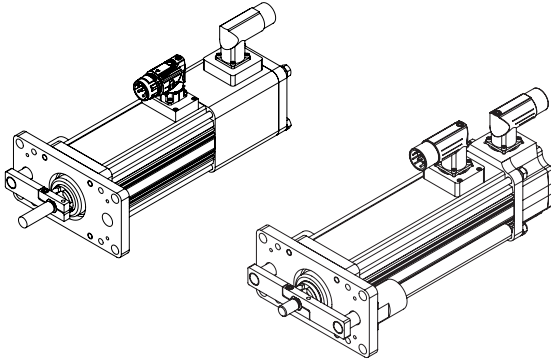

PB = Protective Bellows

This option provides an accordion style protective bellows to protect the main actuator rod from damage due to abrasives or other contaminants in the operating environment. The standard material of this bellows is S2 Neoprene coated nylon with sewn construction. This standard bellows is rated for environmental temperatures of -40 to 250 degrees F. This option requires the main rod of the actuator to be extended beyond standard length. Not available with extended tie rod mounting option. Please contact your local sales representative for details.

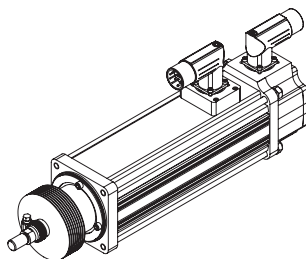

RB = Rear Electric Brake

This option provides an internal holding brake for GSX Series actuators. The brake is spring activated and electrically released.

SR = Splined Main Rod

This option provides a ball spline shafting main rod with a ball spline nut that replaces the standard front seal and bushing assembly. This rod restricts rotation without the need for an external mechanism. The rod diameter will be the closest metric equivalent to our standard rod sizes. Since this option is NOT sealed, it is not suitable for environments in which contaminants may enter the actuator.

Note: This option affects overall length and mounting dimensions for GSX actuators. Consult your local sales representative if using splined main rod. Due to the reduced diameter of the splined main rod on the GSX50, the standard "A", "F", and "B" rod ends are not available and an "X" should be used in the model mask. Please see Actuator Rod Ends with Splined Main Rod Options on page 32 for dimensions.

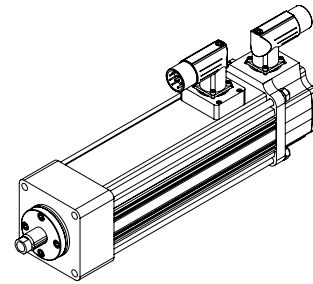

L1, L2, L3 = Adjustable External Travel Switches

This option allows up to 3 external switches to be included with the GSX Series Actuator. These switches provide travel indication to the controller and are adjustable (must purchase external anti-rotate for this option). See page 29 for details.

GSX Series Integrated Motor/Actuator

Motor Speed

All Exlar T-LAM motors and actuators carry a standard motor speed designator (see chart). This is representative of the standard base speed of the motor for the selected bus voltage.

Designator	Base Speed	Actuator/Motor Series
-50	5000 rpm	GSX20
-30	3000 rpm	GSX30, GSX40
-24	2400 rpm	GSX50, GSX60

If the model number is created and the location for the motor speed designator is left blank, this is the base speed to which the motor will be manufactured. The model number can also be created including this standard speed designator.

Feedback

Absolute Feedback

Due to the variability in size of some feedback devices, especially absolute feedback devices which are often very large relative to the size of the actuator motor, the actual size of the actuator may differ in length and width from these drawings for feedback types other than standard resolvers and standard encoders. Please consult Exlar for details. In the event that you order an actuator that differs from these standard dimensions, you will be sent a drawing of the final configuration of your actuator.

Motor Stators

GSX motor options are described with a 3 digit code. The first digit calls out the stack length, the second the rated bus voltage, and the third the number of poles of the motor. Refer to the mechanical/electrical specifications for motor torque and actuator rated force.

118	1 stack	115 Vrms	8 Pole	Class 180 H
138		230 Vrms		
158		400 Vrms		
168	2 stack	460 Vrms	8 Pole	Class 180 H
218		115 Vrms		
238		230 Vrms		
258		400 Vrms		
268	3 stack	460 Vrms	8 Pole	Class 180 H
318		115 Vrms		
338		230 Vrms		
358		400 Vrms		
368		460 Vrms		

* Low voltage stators may be limited to less than catalog rated torque and/or speed. Please contact your local sales representative when ordering this option.

Rod End Attachments

**Rear Clevis Pin
Rod Eye**

**Spherical Rod Eye
Rod Clevis**

See drawings on pages 30-32.

Attachments ordered separate from actuator.

Oil Cooling and Lubrication Option

If you plan to use oil cooling with your GSX actuator, consult your local sales representative to discuss your application.

Exlar GSX actuators are normally delivered with high performance synthetic grease as a lubricant. The application of grease for the roller screw mechanism and bearings has proven adequate in thousands of applications over 25 years. However, in applications where the actuator is operated under high load, high speed and/or high duty cycle for extended periods of time, the grease will degrade prematurely and will eventually fail to provide the lubrication needed to maintain the operating efficiency and integrity of the roller screw and bearings. Continued operation of the actuator after the grease has broken down will cause premature failure of the device.

An ideal way to both lubricate and cool a GSX Series actuator in high performance applications is to flow a small amount of oil at low pressure through the actuator while it is in operation. A small amount of oil flow can, in many cases, allow operation of the actuator beyond normal continuous rated power levels. Oil flow lubrication has been used successfully and extensively in the field, allowing Exlar actuators to deliver thousands of hours of service between re-lubrication intervals even in the most arduous of applications.

Oil lubrication also significantly reduces actuator maintenance, saving valuable production time. With a recirculating oil system, lubricating oil is easily changed without having to access or

dismount the actuator. The ability to monitor oil condition can extend the usable life of the actuator by keeping the lubrication clean and fresh.

Some special application and actuator configuration considerations must be addressed prior to selecting and ordering a GSX actuator with oil lubrication. Please consult with Exlar Application Engineering prior to purchase.

A typical oil flow lubrication system involves use of a commercially available lubrication pump and plumbing to recirculate the oil. A schematic example of a possible oil system is shown below. Exlar Application Engineering can assist you in the development of an appropriate oil system, or recommend a pre-packaged oil circulation system.

If you plan to use oil cooling with your GSX actuator, please consult Exlar to discuss your application.

Oil pressure within the actuator should never exceed 5 psi.

The Oil cooling option will limit maximum actuator acceleration.

Example Oil System Schematic
(Customer Supplied)

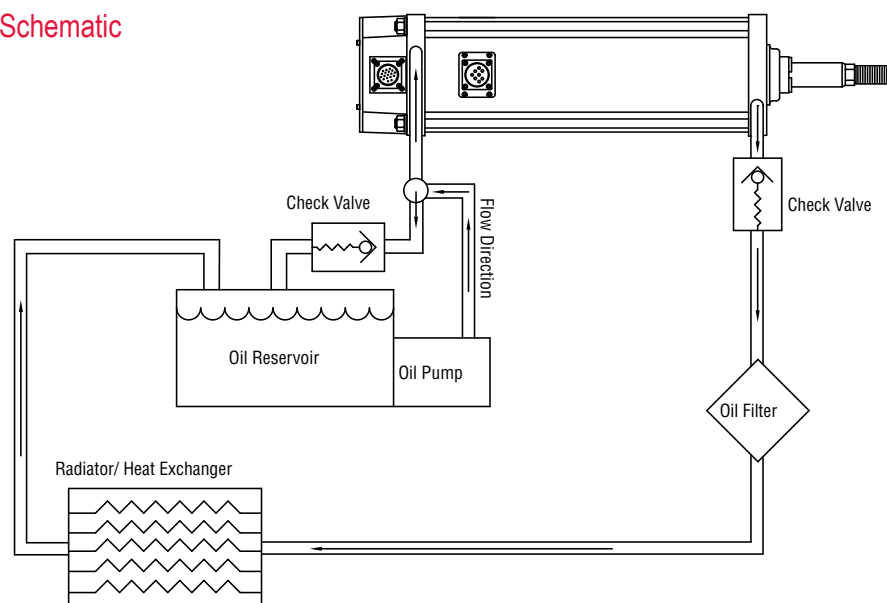

Dimensions Base Actuator

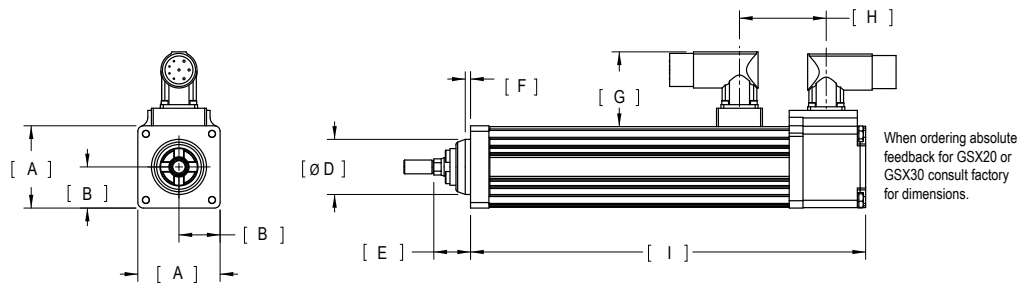

		GSX20	GSX30	GSX40	GSX50	GSX60
A	in	2.24	3.05	3.90	5.50	7.00
	mm	56.9	77.4	99.1	139.7	177.8
B	in	1.12	1.52	1.95	2.75	3.5
	mm	28.4	38.7	49.5	69.9	88.9
Ø D	in	1.500 +0.00/-0.03	2.000 +0.00/-0.03	2.500 +0.00/-0.03	3.000 +0.00/-0.03	3.375 +0.00/-0.03
	mm	38.10 +0.00/-0.08	50.80 +0.00/-0.08	63.50 +0.00/-0.08	76.20 +0.00/-0.08	85.73 +0.00/-0.08
E ⁵	in	1.00	1.32	1.65	2.13	1.94
	mm	25.4	33.5	41.9	54.0	49.4
F	in	0.14	0.09	0.10	0.13	0.13
	mm	3.7	2.3	2.5	3.2	3.2
G	in	2.04	2.04	2.04	2.04	2.04
	mm	51.7	51.7	51.7	51.7	51.7
H ⁴	in	2.36	2.63	2.63	3.09	4.18
	mm	60.0	66.7	66.7	78.6	106.2
I ⁴ (zero stroke)	in	4.8	5.2	6.6	8.3	9.2
	mm	122	133	167	212	235

1. Dimensions shown are for referencing only and are subject to change
2. Dimensions reflect Exlar standard M23 style connectors (option I)
3. Dimensions may vary based on options selected. Consult Exlar for details or refer to drawings provided after receipt of order
4. If ordering a brake, add the following to dimensions H and I:
 GSX20 add 1.78 in (45.2 mm)
 GSX30 add 1.60 in (40.6 mm)
 GSX40 add 2.33 in (59.2 mm)
 GSX50 add 2.50 in (63.5 mm)
 GSX60 add 3.58 in (90.9 mm)
5. If ordering bellows add 2 in (50.8 mm) to dimension E.

Front or Rear Flange Mount

GSX20, GSX50

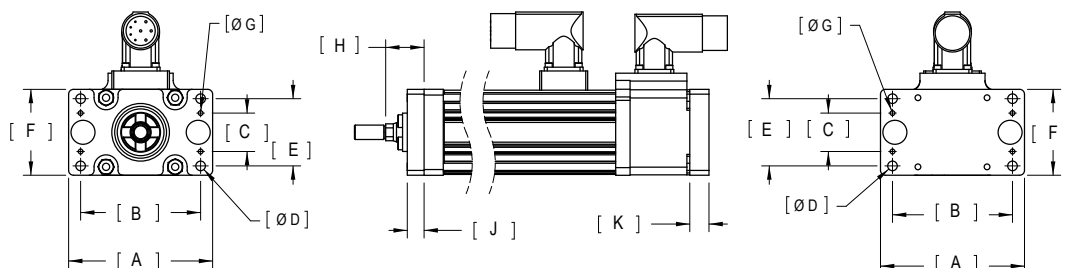

GSX30, GSX40, GSX60

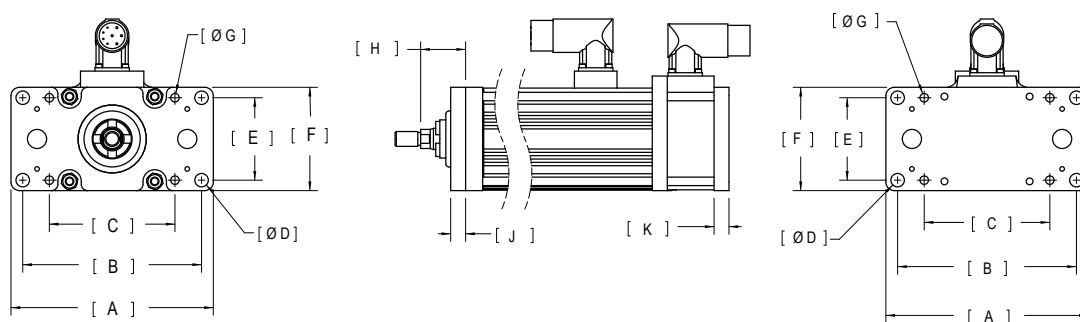

		GSX20	GSX30	GSX40	GSX50	GSX60
A	in	3.75	5.94	7.68	9.50	12.50
	mm	95.3	150.9	195.1	241.3	317.5
B	in	3.13	5.25	6.80	7.63	10.17
	mm	79.4	133.4	172.7	193.7	258.4
C	in	1.00	3.69	5.25	3.25	8.13
	mm	25.4	93.7	133.4	82.6	206.4
Ø D	in	0.250	0.397	0.516	0.563	0.781
	mm	6.35	10.08	13.10	14.29	19.84
E	in	1.75	2.43	2.92	4.88	5.38
	mm	44.5	61.7	74.2	123.8	136.5
F	in	2.24	3.05	3.80	6.50	6.80
	mm	56.8	77.4	96.5	165.1	172.7
Ø G	in	0.125 +0.001/-0.000	0.250 ±0.0005	0.250 ±0.001	0.250 +0.001/-0.000	0.250 +0.0005/-0.0000
	mm	3.18 +0.03/-0.00	6.35 ±0.013	6.35 ±0.025	6.35 +0.03/0.00	6.35 +0.013/0.000
H¹	in	1.00	1.32	1.65	2.13	1.94
	mm	25.4	33.5	41.9	54.0	49.4
J¹	in	0.44	0.44	0.63	0.75	0.75
	mm	11.1	11.1	15.9	19.1	19.1
K	in	0.50	0.44	0.63	0.75	1.31
	mm	12.7	11.1	15.9	19.1	33.3

- If ordering a splined main rod, add the following to dimensions H and J:
 GSX20 add .50 in (12.7 mm), GSX30 add 1.20 in (30.5 mm), GSX40 add 1.77 in (45.0 mm)
 GSX50 add 2.06 in (52.3 mm), GSX60 add 2.73 in (69.3 mm)

Pre-sale drawings and models are representative and are subject to change. Certified drawings and models are available for a fee. Consult your local Exlar representative for details.

GSX Series Integrated Motor/Actuator

Side Mount or Extended Tie Rod Mount

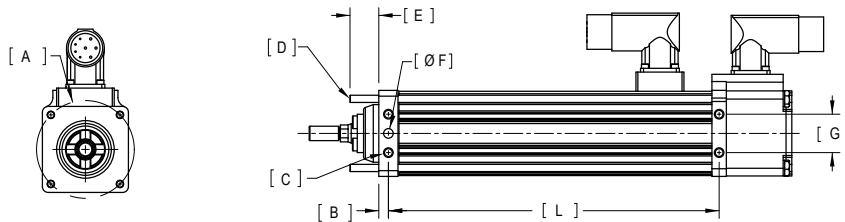

		GSX20	GSX30	GSX40	GSX50	GSX60
Ø A	in	2.546	3.536	4.243	6.125	7.778
	mm	64.66	89.80	107.76	155.58	197.57
B²	in	0.25	0.25	0.31	0.41	0.44
	mm	6.4	6.4	7.9	10.3	11.1
C¹	in	1/4-20 UNC	1/4-20 UNC	3/8-16 UNC	1/2-13 UNC	5/8-11 UNC
	mm	M6 x 1.0	M6 x 1.0	M10 x 1.5	M12 x 1.75	M16 x 2
D	in	10-24 UNC	1/4-20 UNC	3/8-16 UNC	1/2-13 UNC	9/16-12 UNC
	mm	M5 x 0.8	M6 x 1.0	M8 x 1.25	M12 x 1.75	M14 x 2
E	in	0.75	0.96	1.38	1.50	1.65
	mm	19.1	24.4	35.1	38.1	41.9
Ø F	in	0.2500 +0/-0.0005 \downarrow 0.25	0.2500 +0/-0.0005 \downarrow 0.25	0.3750 +0/-0.0005 \downarrow 0.44	0.5000 +0/-0.0005 \downarrow 0.50	0.5000 +0/-0.0005 \downarrow 0.62
	mm	6 mm M7 \downarrow 9.0	6 mm M7 \downarrow 9.5	8 mm M7 \downarrow 12.0	12 mm M7 \downarrow 12.0	12 mm M7 \downarrow 12.0"
G	in	1.00	1.75	1.75	3.00	3.00
	mm	25.4	44.5	44.5	76.2	76.2
L (zero stroke)	in	2.6	3.1	4.3	5.1	5.9
	mm	67	80	109	130	150

- Side mount options D and K = 8X for dimension C
- If ordering a splined main rod, add the following to dimension B:
 - GSX20 add .50 in (12.7 mm)
 - GSX30 add 1.20 in (30.5 mm)
 - GSX40 add 1.77 in (45.0 mm)
 - GSX50 add 2.06 in (52.3 mm)
 - GSX60 add 2.73 in (69.3 mm)

Pre-sale drawings and models are representative and are subject to change. Certified drawings and models are available for a fee. Consult your local Exlar representative for details.

Side Trunnion Mount of Rear Clevis Mount

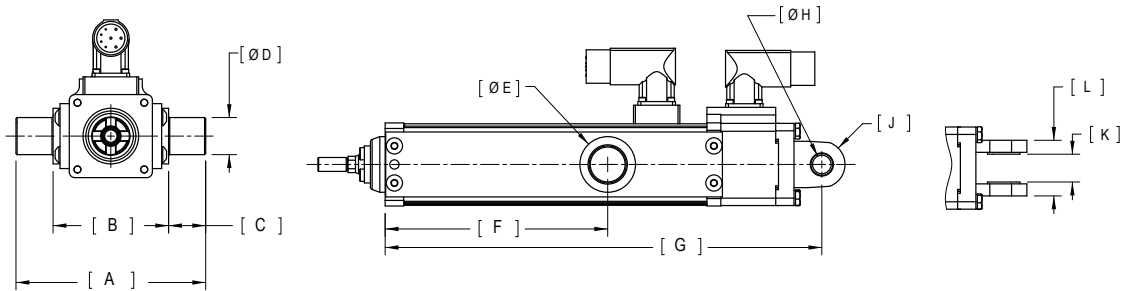

		GSX20	GSX30	GSX40	GSX50	GSX60
A	in	5.12	5.92	6.90	10.00	12.55
	mm	129.9	150.4	175.2	254.0	318.8
B	in	3.12	3.92	4.90	7.00	8.55
	mm	79.1	99.6	124.4	177.8	217.2
C	in	1.00	1.00	1.00	1.50	2.00
	mm	25.4	25.4	25.4	38.1	50.8
Ø D	in	1.000 +/-0.001	1.000 +/-0.001	1.500 +/-0.001	2.000 +/-0.001	2.500 +/-0.001
	mm	25 h7	25 h7	35 h7	50 h7	60 h9
Ø E	in	1.50	1.50	2.00	2.50	3.50
	mm	38.1	38.1	50.8	63.5	88.9
F (3" stroke)	in	3.0	5.4	NA	NA	NA
	mm	76	137	NA	NA	NA
F (4" stroke)	in	NA	NA	4.0	NA	NA
	mm	NA	NA	102	NA	NA
F (6" stroke)	in	6.0	6.0	6.0	6.0	6.0
	mm	152	152	152	152	152
F (8" stroke)	in	NA	NA	8.0	NA	NA
	mm	NA	NA	203	NA	NA
F (10" stroke)	in	10.0	10.0	10.0	10.0	10.0
	mm	254	254	254	254	254
F (12" stroke)	in	12.0	12.0	12.0	NA	NA
	mm	305	305	305	NA	NA
F (14" stroke)	in	NA	14.0	NA	14.0	NA
	mm	NA	356	NA	356	NA
F (18" stroke)	in	NA	18.0	18.0	NA	NA
	mm	NA	457	457	NA	NA
G ¹ (zero stroke)	in	5.8	6.5	8.3	10.6	12.5
	mm	147	165	210	269	318
Ø H	in	0.500 +0.002/-0.001	0.750 +0.002/-0.001	0.750 +0.002/-0.001	1.000 +0.002/-0.001	1.750 +0.002/-0.001
	mm	12 H9	20 H9	20 H9	25 H9	45 H9
J	in	0.63	0.75	0.75	1.00	2.13
	mm	15.9	19.1	19.1	25.4	54.0
K	in	0.75	1.25	1.25	1.50	2.50
	mm	19.1	31.8	31.8	38.1	63.5
L	in	1.50	2.50	2.50	3.00	5.00
	mm	38.1	63.5	63.5	76.2	127.0

- If ordering a brake, add the following to dimension G:
 GSX20 add 1.78 in (45.2 mm), GSX30 add 1.60 in (40.6 mm), GSX40 add 2.33 in (59.2 mm),
 GSX50 add 2.5 in (63.5 mm), GSX60 add 3.58 in (90.9 mm)

Pre-sale drawings and models are representative and are subject to change. Certified drawings and models are available for a fee. Consult your local Exlar representative for details.

GSX Series Integrated Motor/Actuator

Rear Brake Extension Option

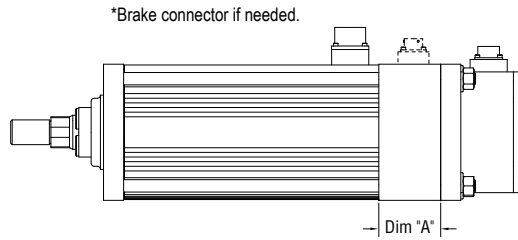

	GSX20	GSX30	GSX40	GSX50	GSX60
A in (mm)	1.78 (45.2)	1.60 (40.6)	2.33 (59.2)	2.50 (63.5)	3.58 (90.9)

*Consult Exlar for connector and wiring information if ordering brake option.

Anti-rotation Option GSX/M20, GSX/M30, GSX/M40 and GSX60

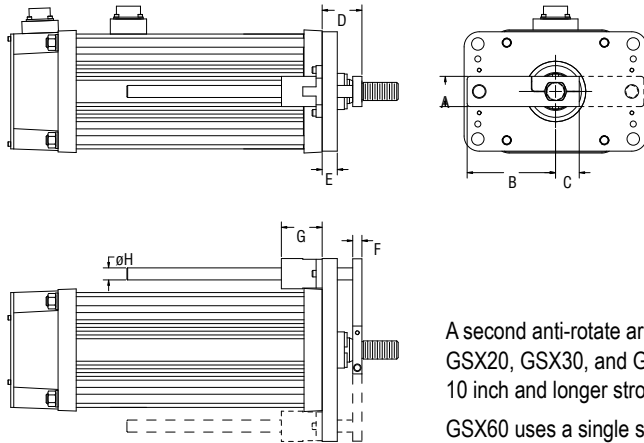

Dims in (mm)	GSX20	GSX30	GSX40	GSX60
A	0.60 (15.2)	0.79 (20.1)	1.25 (31.8)	1.75 (44.5)
B	1.81 (46.0)	2.54 (64.5)	3.78 (96.0)	5.79 (147)
C	0.54 (13.7)	0.71 (18.0)	0.98 (24.9)	1.55 (39.4)
D	1.00 (25.4)	1.30 (33.0)	1.64 (41.7)	1.94 (49.3)
E	0.44 (11.2)	0.44 (11.2)	0.63 (16.0)	0.75 (19.1)
F	0.28 (7.11)	0.32 (8.13)	0.38 (9.65)	0.50 (12.7)
G	0.31 (7.87)	1.69 (42.9)	1.69 (42.9)	2.81 (71.4)
øH	0.37 (9.40)	0.50 (12.7)	0.50 (12.7)	1.00 (25.4)

A second anti-rotate arm is used on GSX20, GSX30, and GSX40 models with 10 inch and longer stroke lengths.

GSX60 uses a single sided anti-rotate for all stroke lengths.

Anti-rotation Option GSX50

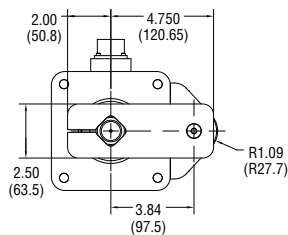

NOTE: GSX50 actuators use one arm for all stroke lengths.

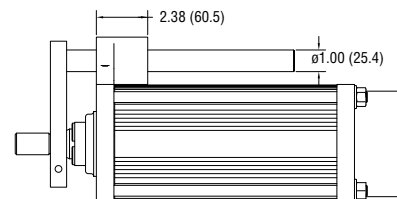
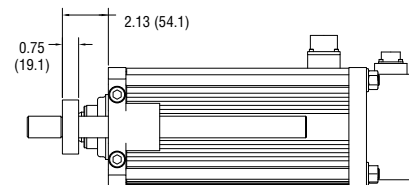

Pre-sale drawings and models are representative and are subject to change. Certified drawings and models are available for a fee. Consult your local Exlar representative for details.

External Limit Switch Option

The external limit switch option (requires anti-rotate option) for the GSX Series of linear actuators provides the user with 1, 2, or 3 externally mounted adjustable switches for use as the end of travel limit switches or home position sensors.

The number of switches desired is selected by ordering the L1, L2, or L3 option, in which 1, 2 or 3 switches will be provided, respectively.

The switches are 9-30 VDC powered, PNP output, with either normally open or normally closed logic operation depending on the switch configuration ordered. Switches are supplied with 1 meter of 3-wire embedded cable. Below is a diagram indicating which logic operation will be provided for each switch, based on the option ordered.

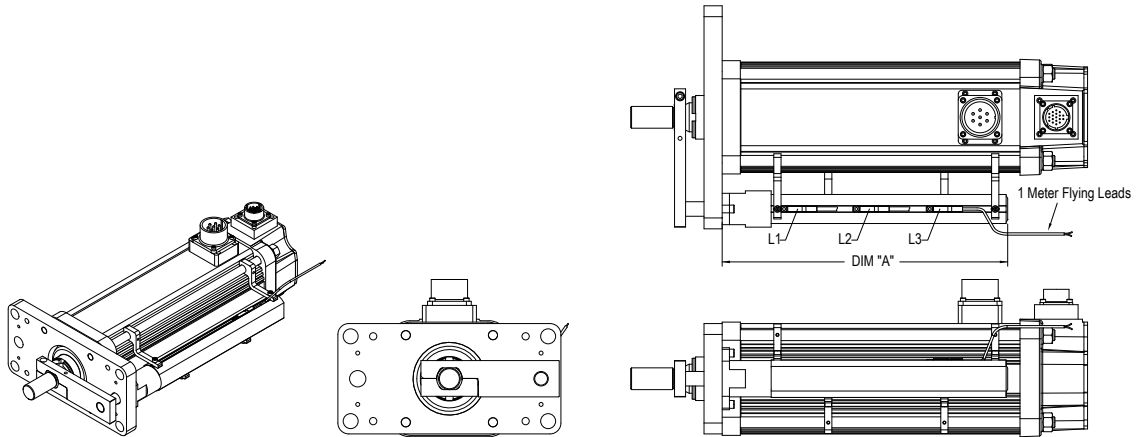

Dim A	3 inch (76 mm) stroke in (mm)	6 inch (152 mm) stroke in (mm)	8 inch (203 mm) stroke in (mm)	10 inch (254 mm) stroke in (mm)	12 inch (305 mm) stroke in (mm)	14 inch (355 mm) stroke in (mm)	18 inch (457 mm) stroke in (mm)
GSX20	5.515 (140.1)	8.515 (216.3)	NA	12.500 (317.5)	14.515 (368.7)	NA	NA
GSX30	6.932 (176.1)	9.832 (249.7)	NA	13.832 (351.3)	15.832 (402.1)	17.832 (452.9)	21.832 (554.5)
GSX40	NA	9.832 (249.7)	11.83 (300.5)	13.832 (351.3)	15.832 (402.1)	NA	21.832 (554.5)
GSX50	NA	11.667 (296.3)	NA	15.667 (397.9)	NA	19.667 (499.5)	NA
GSX60	NA	10.461 (265.7)	NA	14.461 (367.3)	NA	NA	NA

Option	SW1	SW2	SW3
L1	Not Supplied	Normally Open	Not Supplied
L2	Normally Closed	Not Supplied	Normally Closed
L3	Normally Closed	Normally Open	Normally Closed

Switch Type	Exlar Part Number	Turck Part Number
Normally Closed Switch	43404	BIM-UNT-RP6X
Normally Open Switch	43403	BIM-UNT-AP6X

Pre-sale drawings and models are representative and are subject to change. Certified drawings and models are available for a fee. Consult your local Exlar representative for details.

GSX Series Integrated Motor/Actuator

Actuator Rod End Options

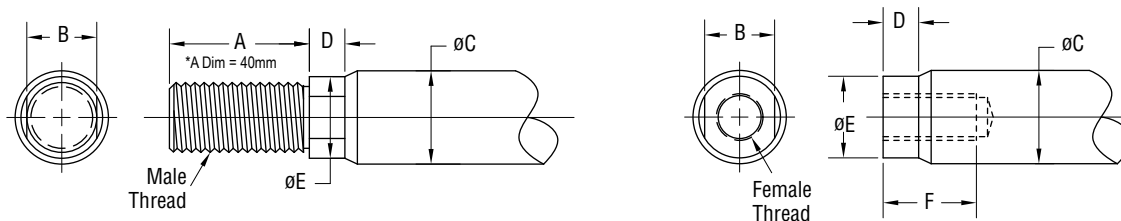

Standard Rod End

	A	B	øC	D	øE	F	Male U.S.	Male Metric	Female U.S.	Female Metric
GSX20 in (mm)	0.813 (20.7)	0.375 (9.5)	0.500 (12.7)	0.200 (5.1)	0.440 (11.2)	0.750 (19.1)	3/8 – 24 UNF – 2A	M8 x 1 6g	5/16 – 24 UNF – 2B	M8 x 1 6H
GSX30 in (mm)	0.750* (19.1)	0.500 (12.7)	0.625 (15.9)	0.281 (7.1)	0.562 (14.3)	0.750 (19.1)	7/16 – 20 UNF – 2A	M12 x 1.75* 6g	7/16 – 20 UNF – 2B	M10 x 1.5 6H
GSX40 in (mm)	1.500 (38.1)	0.750 (19.1)	1.000 (25.4)	0.381 (9.7)	0.875 (22.2)	1.000 (25.4)	3/4 – 16 UNF – 2A	M16 x 1.5 6g	5/8 – 18 UNF – 2B	M16 x 1.5 6H
GSX50 in (mm)	1.625 (41.3)	1.125 (28.6)	1.375 (34.9)	0.750 (19.1)	1.250 (31.8)	1.750 (44.5)	1 – 14 UNS – 2A	M27 x 2 6g	1 – 14 UNS – 2B	M24 x 2 6H
GSX60 in (mm)	2.500 (63.5)	1.250 (31.8)	1.750 (44.5)	0.550 (14.0)	1.625 (41.3)	1.750 (44.5)	1 1/4 – 12 UNF – 2A	M30 x 2 6g	7/8 – 14 UNF – 2B	M25 x 1.5 6H

Rod End with Splined Main Rod

	A	B	C	D	E	F	Male U.S.	Male Metric	Female U.S.	Female Metric
GSX20 in (mm)	0.813 (20.7)	0.375 (9.5)	0.512 (13.0)	0.200 (5.1)	0.440 (11.2)	0.750 (19.1)	3/8 – 24 UNF – 2A	M8 x 1 6g	5/16 – 24 UNF – 2B	M8 x 1 6H
GSX30 in (mm)	0.750* (19.1)	0.500 (12.7)	0.630 (16.0)	0.281 (7.1)	0.562 (14.3)	0.750 (19.1)	7/16 – 20 UNF – 2A	M12 x 1.75* 6g	7/16 – 20 UNF – 2B	M10 x 1.5 6H
GSX40 in (mm)	1.500 (38.1)	0.750 (19.1)	0.906 (23.0)	0.381 (9.7)	0.875 (22.2)	1.000 (25.4)	3/4 – 16 UNF – 2A	M16 x 1.5 6g	5/8 – 18 UNF – 2B	M16 x 1.5 6H
GSX50**** in (mm)	1.625 (41.3)	1.000** (25.4)	1.102 (28.0)	0.750*** (19.1)	1.102 (28.0)	1.500 (38.1)	1 – 14 UNS – 2A	M24 x 2 6g	3/4 – 16 UNF – 2B	M20 x 1.5 6H
GSX60 in (mm)	2.500 (63.5)	1.250 (31.8)	1.850 (47.0)	0.550 (14.0)	1.625 (41.3)	1.750 (44.5)	1 1/4 – 12 UNF – 2A	M30 x 2 6g	7/8 – 14 UNF – 2B	M25 x 1.5 6H

* When Male, Metric (A), Dimension A = 1.575 (40 mm)

** When Male, Metric (A), Dimension B = 0.945 (24 mm)

***When Male (M or A) = 0.500 in (12.7 mm)

****When GSX50 is ordered with a splined rod thread, dimensions are different in accordance with the table.

Part numbers for rod attachment options indicate the through hole size or pin diameter. Before selecting a spherical rod eye please consult the information on the anti-rotation option for the GSX actuators. Spherical rod eyes will allow the rod to rotate if the load is not held.

Pre-sale drawings and models are representative and are subject to change. Certified drawings and models are available for a fee. Consult your local Exlar representative for details.

Rod Clevis

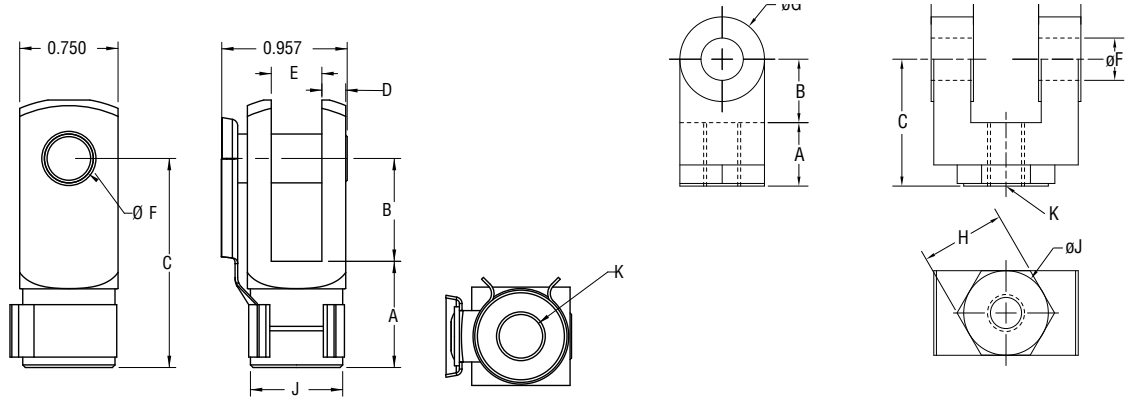

Dimensions for RC038

Dimensions for RC050, RC075, RC100, RC138

	A	B	C	D	E	øF	øG	H	øJ	K
GSX20 RC038 in (mm)	0.810 (20.6)	0.785 (19.9)	1.595 (40.5)	0.182 (4.6)	0.386 (9.8)	0.373 (9.5)	0.951 (24.2)	NA	NA	3/8-24
GSX30 RC050 in (mm)	0.75 (19.1)	0.75 (19.1)	1.50 (38.1)	0.50 (12.7)	0.765 (19.43)	0.50 (12.7)	1.00 (25.4)	1.00 (25.4)	1.00 (25.4)	7/16-20
GSX40 RC075 in (mm)	1.125 (28.58)	1.25 (31.75)	2.375 (60.3)	0.625 (15.88)	1.265 (32.13)	0.75 (19.1)	1.50 (38.1)	1.25 (31.75)	1.25 (31.75)	3/4-16
GSX50 RC100 in (mm)	1.625 (41.2)	1.500 (38.1)	3.125 (79.4)	0.750 (19.1)	1.515 (38.5)	1.000 (25.4)	2.000 (50.8)	1.500 (38.1)	1.500 (38.1)	1-14
GSX60 RC138 in (mm)	2.00 (50.8)	2.125 (53.98)	4.125 (104.78)	1.00 (25.4)	2.032 (51.6)	1.375 (34.93)	2.75 (69.85)	2.00 (50.8)	2.00 (50.8)	1-1/4 - 12

Spherical Rod Eye Dimensions

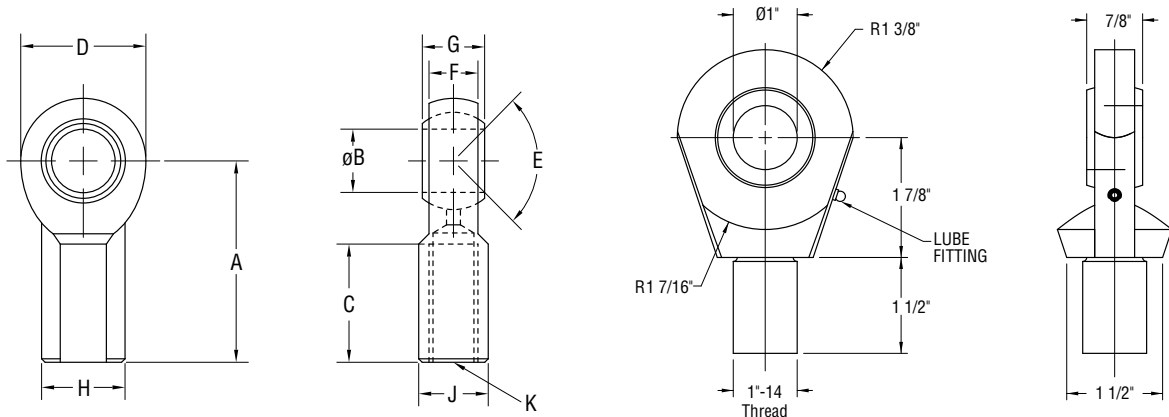

Dimensions for SRM038, SRM044, SRM075

Dimensions for SRF100

	A	øB	C	D	E	F	G	H	J	K
GSX20 SRM038 in (mm)	1.625 (41.3)	.375 (9.525)	.906 (23.0)	1.0 (25.6)	12 deg	.406 (10.3)	.500 (12.7)	.688 (17.7)	.562 (14.3)	3/8-24
GSX30 SRM044 in (mm)	1.81 (46.0)	0.438 (11.13)	1.06 (26.9)	1.13 (28.7)	14 deg	0.44 (11.1)	0.56 (14.2)	0.75 (19.1)	0.63 (16.0)	7/16-20
GSX40 SRM075 in (mm)	2.88 (73.2)	0.75 (19.1)	1.72 (43.7)	1.75 (44.5)	14 deg	0.69 (17.5)	0.88 (22.3)	1.13 (28.7)	1.00 (25.4)	3/4-16
GSX50 SRF100 in (mm)	See GSX50 Special Rod Eye drawing to the right above. Requires female rod end.									

Pre-sale drawings and models are representative and are subject to change. Certified drawings and models are available for a fee. Consult your local Exlar representative for details.

GSX Series Integrated Motor/Actuator

Rod Eye

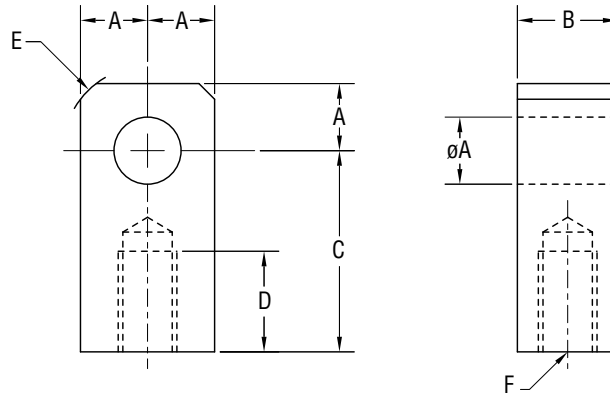

	ϕA	B	C	D	E	F
GSX20 RE038 in (mm)	0.50 (12.7)	0.560 (14.2)	1.000 (25.4)	0.500 (12.7)	0.25 x 45°	3/8 - 24
GSX30 RE050 in (mm)	0.50 (12.7)	0.75 (19.1)	1.50 (38.1)	0.75 (19.1)	0.63 (15.9)	7/16 - 20
GSX40 RE075 in (mm)	0.75 (19.1)	1.25 (31.8)	2.06 (52.3)	1.13 (28.7)	0.88 (22.3)	3/4 - 16
GSX50 RE100 in (mm)	1.00 (25.4)	1.50 (38.1)	2.81 (71.4)	1.63 (41.4)	1.19 (30.2)	1 - 14
GSX60 RE138 in (mm)	1.375 (34.93)	2.0 (50.8)	3.44 (87.3)	2.0 (50.8)	1.837 (46.67)	1 1/4 - 12

Clevis Pin Dimensions

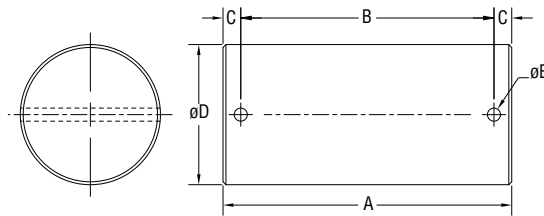

	A	B	C	ϕD	ϕE
CP050 ¹ in (mm)	2.28 (57.9)	1.94 (49.28)	0.17 (4.32)	0.50 ^{-0.001/-0.002} (12.7 mm +0.00/-0.05)	0.106 (2.69)
CP075 ² in (mm)	3.09 (78.5)	2.72 (69.1)	0.19 (4.82)	0.75 ^{-0.001/-0.002} (19.1 mm +0.00/-0.05)	0.14 (3.56)
CP100 ³ in (mm)	3.59 (91.2)	3.22 (81.8)	0.19 (4.82)	1.00 ^{-0.001/-0.002} (25.4 mm +0.00/-0.05)	0.14 (3.56)
CP138 ⁴ in (mm)	4.66 (118.3)	4.25 (108)	0.20 (5.08)	1.375 ^{-0.001/-0.002} (34.93 mm +0.00/-0.05)	0.173 (4.39)
CP175 ⁵ in (mm)	5.656 (143.6)	5.25 (133.3)	0.203 (5.15)	1.750 ^{-0.001/-0.002} (44.4 mm +0.00/-0.05)	0.173 (4.39)

¹ Fits GSX20 and GSX30 rear clevis, RCI050 and REI050

² Fits GSX30, 40 and RC075, RE075 and SMR075

³ Fits GSX50 rear clevis, RC100, RE100

⁴ Fits RC138, RE138

⁵ Fits GSX60 rear clevis

Pre-sale drawings and models are representative and are subject to change. Certified drawings and models are available for a fee. Consult your local Exlar representative for details.

[Return to Table of Contents](#)

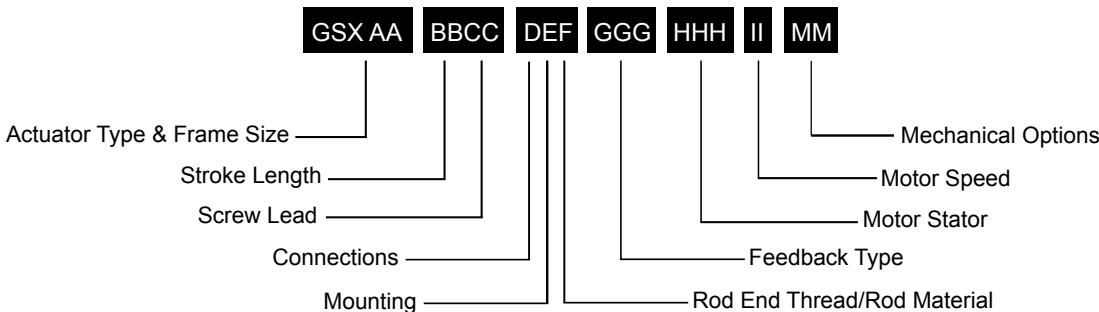

AA = GSX Actuator Frame Size (Nominal)

- 20 = 2 in (50.8 mm)
- 30 = 3 in (76.2 mm)
- 40 = 4 in (101.6 mm)
- 50 = 5.5 in (139.7 mm)
- 60 = 7 in (177.8 mm)

BB = Stroke Length

- 03 = 3 in (76 mm) GSX20, GSX30
- 04 = 4 in (102 mm) GSX40
- 06 = 5.9 in (150 mm) GSX30; 6 in (152 mm) GSX20, GSX40, GSX50, GSX60
- 08 = 8 in (203 mm) GSX40
- 10 = 10 in (254 mm) all models
- 12 = 12 in (305 mm) GSX20, GSX30, GSX40
- 14 = 14 in (356 mm) GSX30, GSX50
- 18 = 18 in (457 mm) GSX30, GSX40

CC = Screw Lead

- 01 = 0.1 in (2.54 mm) (GSX20, GSX30, GSX40, GSX50)⁹
- 02 = 0.2 in (5.08 mm) (GSX20, GSX30, GSX40, GSX50)
- 03 = 0.25 in (6.35 mm) (GSX60)
- 04 = 0.4 in (10.16 mm) (GSX20 only)
- 05 = 0.5 in (12.7 mm) (GSX30, GSX40, GSX50, GSX60)
- 08 = 0.75 in (19.05 mm) (GSX40)⁵
- 10 = 1.0 in (25.4 mm) (GSX50, GSX60)⁶

D = Connections

- I = Exlar standard M23 style⁷
- M = Manufacturer's connector³

E = Mounting

- C = Rear clevis
- F = Front flange
- R = Rear flange
- D = Double side mount¹³
- T = Side trunnion
- E = Extended tie rods
- K = Metric double side mount¹³
- Q = Metric side trunnion
- M = Metric extended tie rods
- G = Metric rear clevis

F = Rod End Thread / Rod Material

- M = Male, US standard thread
- A = Male, metric thread
- F = Female, US standard thread
- B = Female, metric thread

GGG = Feedback Type

See page 164 for detailed information.

HHH = Motor Stator – 8 Pole¹ Class 180H¹²

- 118 = 1 stack, 115 Vrms
- 138 = 1 stack, 230 Vrms
- 158 = 1 stack, 400 Vrms
- 168 = 1 stack, 460 Vrms
- 218 = 2 stack, 115 Vrms
- 238 = 2 stack, 230 Vrms
- 258 = 2 stack, 400 Vrms
- 268 = 2 stack, 460 Vrms
- 318 = 3 stack, 115 Vrms
- 338 = 3 stack, 230 Vrms
- 358 = 3 stack, 400 Vrms
- 368 = 3 stack, 460 Vrms

II = Motor Speed

- 24 = 2400 rpm, GSX50, GSX60
- 30 = 3000 rpm, GSX30, GSX40
- 50 = 5000 rpm, GSX20

MM = Mechanical Options¹⁵

- AR = External anti-rotate assembly¹¹
- RB = Rear electric brake²
- PB = Protective bellows¹⁰
- SR = Splined main rod^{8, 12, 14}
- L1/L2/L3 = External limit switches⁴

NOTES:

1. Stator voltage and pole options allow for catalog rated performance at varying amplifier bus voltages and pole configuration requirements. Refer to performance specification on pages 7-9 for availability of 3 stack stator.
2. The brake option may require a third cable, consult local sales representative.
3. Available as described in Feedback Types.
4. Requires AR option.
5. 0.75 lead not available above 12 inch.
6. 1.0 lead not available above 10 inch stroke.
7. GSX60 uses M40 size 1.5 power connector.
8. If not otherwise specified by the customer, an M24X2 male rod end will be used on the GSX50. See note on page 30.
9. 0.1 lead not available over 10" stroke on GSX50.
10. N/A with extended tie rod mounting option.
11. A second anti-rotate arm is used on GSX20, 30 and 40 for 10 inch and longer stroke.
12. See page 22 for optimized stator offerings.
13. Anti-rotate with D or K mount N/A on 10 inch or longer stroke except in GSX50.
14. Not available in Stainless Steel.
15. For extended temperature operation consult factory for model number.

For cables and accessories, see page 160.



For options or specials not listed above or for extended temperature operation, please contact Exlar