

SVTE-A-B40-CanOpen Servo Drives

60VDC | 10A
DC motors, BLDC motors

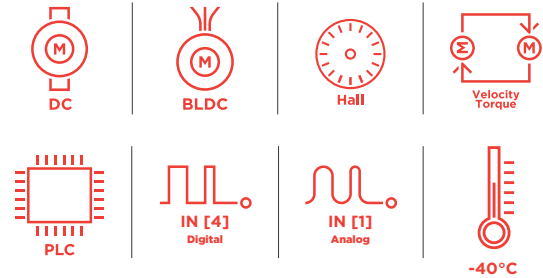
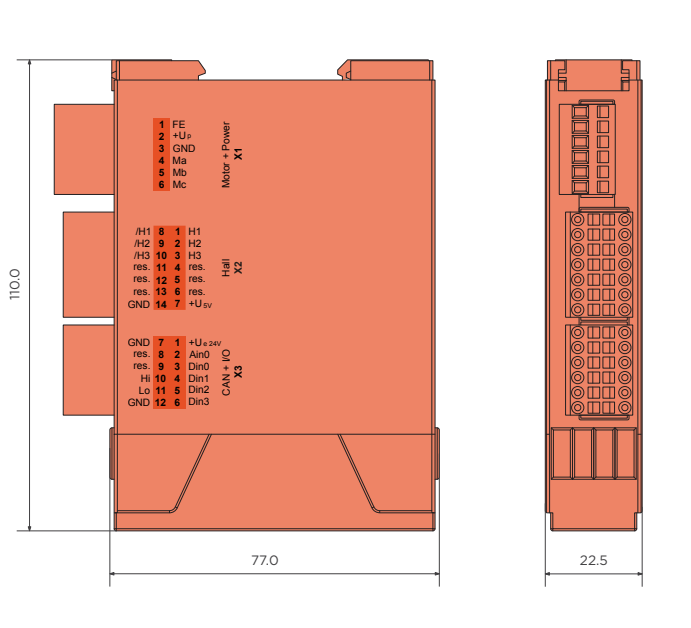

CANopen

| Values | Unit |
|---|---|
| Power | |
| 1 Electronic supply voltage U _e | VDC 9..30 |
| 2 Power supply voltage U _p | VDC 9..60 |
| 3 Max. output current | A 30 |
| 4 Continuous output current @ U _p =24VDC | A 10 |
| 5 Continuous output current @ U _p =48VDC | A 8.5 |
| 6 Output voltage | Up to 90% |
| Motor types | |
| 7 DC motors | yes |
| 8 BLDC motors | yes |
| 9 Stepper motors | no |
| Mechanical | |
| 10 Size LxWxH | mm 110 x 22.5 x 77 |
| CAN bus | |
| 11 Protocol | DS301 |
| 12 Galvanically isolated | no |
| Hall sensors | |
| 13 Input voltage (24VDC tolerant) | VDC 0..5 |
| 14 Signal type | differential, open collector, single ended, 5VDC pull up intern 920 Ohm |
| Digital input | |
| 15 Number | 4 (Din0..3) |
| Analog inputs | |
| 16 Number | 1 (Ain0) |
| Environment | |
| 17 Operating temperature | °C -40...+70 |

Connection

| X1 Motor | | |
|--------------------------|---------|---|
| 1 | FE | Functional earth |
| 2 | +Up | Power supply voltage |
| 3 | GND | Ground for power supply voltage |
| 4 | Ma | Motor phase A |
| 5 | Mb | Motor phase B |
| 6 | Mc | Motor phase C |
| X2 Hall and inc. encoder | | |
| 1 | H1 | Hall sensor 1 |
| 2 | H2 | Hall sensor 2 |
| 3 | H3 | Hall sensor 3 |
| 4 | res. | Reserved |
| 5 | res. | Reserved |
| 6 | res. | Reserved |
| 7 | +U5V | 5V output voltage for sensor supply Sensors: encoder, hall |
| 8 | /H1 | Hall sensor 1 inverted |
| 9 | /H2 | Hall sensor 2 inverted |
| 10 | /H3 | Hall sensor 3 inverted |
| 11 | res. | Reserved |
| 12 | res. | Reserved |
| 13 | res. | Reserved |
| 14 | GND | Ground for sensor supply (don't connect with system GND) |
| X3 I/O's and CAN | | |
| 1 | +Ue24V | Electronic supply voltage |
| 2 | Ain0 | Analog input 0 |
| 3 | Din0 | Digital input 0 |
| 4 | Din1 | Digital input 1 |
| 5 | Din2 | Digital input 2 |
| 6 | Din3 | Digital input 3 |
| 7 | GND | Ground for electronic supply voltage |
| 8 | res. | Reserved |
| 9 | res. | Reserved |
| 10 | CAN Hi | CAN High |
| 11 | CAN Lo | CAN Low |
| 12 | CAN GND | CAN Ground |

SVTE-A-E25-CanOpen Servo Drives

60VDC | 35A
DC motors, BLDC motors

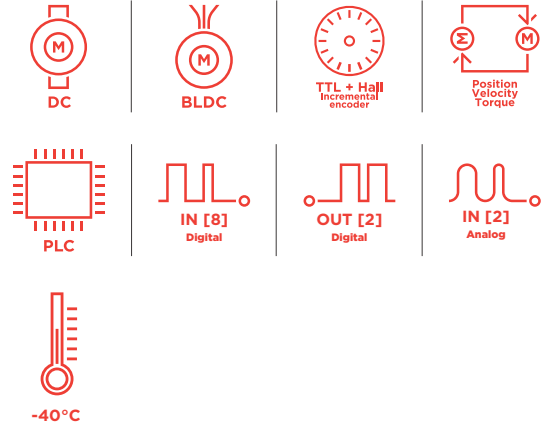
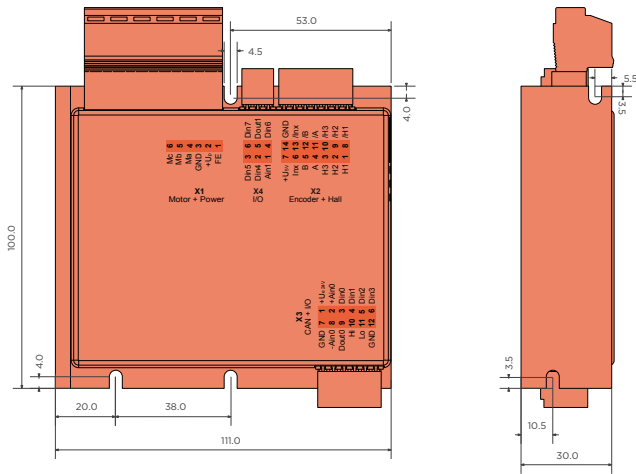

CANopen

| Values | Unit |
|--|--|
| Power | |
| 1 Electronic supply voltage U_e | VDC 9..30 |
| 2 Power supply voltage U_p | VDC 9..60 |
| 3 Max. output current | A 100 |
| 4 Continuous output current @ $U_p=24VDC$ | A 35 |
| 5 Continuous output current @ $U_p=48VVDC$ | A 26 |
| 6 Output voltage | Up to 100% |
| Motor types | |
| 7 DC motors | yes |
| 8 BLDC motors | yes |
| 9 Stepper motors | no |
| Mechanical | |
| 10 Size LxWxH | mm 111 x 100 x 30 |
| CAN bus | |
| 11 Protocol | DS301 |
| 12 Device profile | DS402 |
| 13 Galvanically isolated | yes |
| Incremental encoder | |
| 14 Input voltage (24VDC tolerant) | VDC 0..5 |
| 15 Signal type | differential, open collector, single ended |
| Hall sensors | |
| 16 Input voltage (24VDC tolerant) | VDC 0..5 |
| 17 Signal type | differential, open collector, single ended |
| Digital input | |
| 18 Number | 8 (Din0..7) |
| Digital output | |
| 19 Number | 2 (Dout0..1) |
| 20 Continuous output current | A 1.5 (Load: resistive, inductive) |
| Analog inputs | |
| 21 Number | 2 (Ain0..1) |
| 22 Signal type - Ain0 | +/- 10 VDC, 12 Bit, differential |
| 23 Signal type - Ain1 | +/- 10 VDC, 12 Bit, single ended |
| Environment | |
| 24 Operating temperature | °C -40...+70 |

Connection

| X1 Motor | | |
|--------------------------|---------|---|
| 1 | FE | Functional earth |
| 2 | +Up | Power supply voltage |
| 3 | GND | Ground for power supply voltage |
| 4 | Ma | Motor phase A |
| 5 | Mb | Motor phase B |
| 6 | Mc | Motor phase C |
| X2 Hall and inc. encoder | | |
| 1 | H1 | Hall sensor 1 |
| 2 | H2 | Hall sensor 2 |
| 3 | H3 | Hall sensor 3 |
| 4 | A | Inc. encoder, A channel |
| 5 | B | Inc. encoder, B channel |
| 6 | Inx | Inc. encoder, index channel |
| 7 | +U5V | 5V output voltage for sensor supply Sensors: encoder, hall |
| 8 | /H1 | Hall sensor 1 inverted |
| 9 | /H2 | Hall sensor 2 inverted |
| 10 | /H3 | Hall sensor 3 inverted |
| 11 | /A | Inc. encoder, A channel invert |
| 12 | /B | Inc. encoder, B channel inverted |
| 13 | /Inx | Inc. encoder, index channel inverted |
| 14 | GND | Ground for sensor supply (don't connect with system GND) |
| X3 I/O's and CAN | | |
| 1 | +Ue24V | Electronic supply voltage |
| 2 | +Ain0 | Analog input 0, positive |
| 3 | Din0 | Digital input 0 |
| 4 | Din1 | Digital input 1 |
| 5 | Din2 | Digital input 2 |
| 6 | Din3 | Digital input 3 |
| 7 | GND | Ground for electronic supply voltage |
| 8 | -Ain0 | Analog input 0, negative |
| 9 | Dout0 | Digital output 0 |
| 10 | CAN Hi | CAN High |
| 11 | CAN Lo | CAN Low |
| 12 | CAN GND | CAN Ground |
| X4 I/O's | | |
| 1 | Ain1 | Analog input 1 |
| 2 | Din4 | Digital input 4 |
| 3 | Din5 | Digital input 5 |
| 4 | Din6 | Digital input 6 |
| 5 | Dout1 | Digital output 1 |
| 6 | Din7 | Digital input 7 |

SVTE-A-E25-EtherCAT Servo Drives

60VDC | 35A
DC motors, BLDC motors

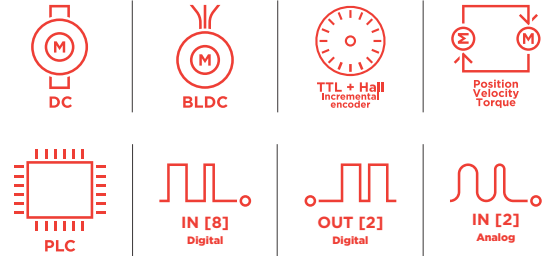
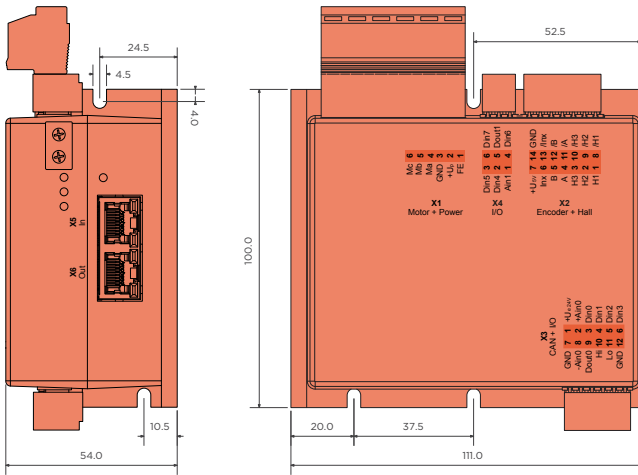

CANopen | EtherCAT

| Values | Unit |
|--|--|
| Power | |
| 1 Electronic supply voltage Ue | VDC 9..30 |
| 2 Power supply voltage Up | VDC 9..60 |
| 3 Max. output current | A 100 |
| 4 Continuous output current @ Up=24VDC | A 35 |
| 5 Continuous output current @ Up=48VDC | A 26 |
| 6 Output voltage | Up to 100% |
| Motor types | |
| 7 DC motors | yes |
| 8 BLDC motors | yes |
| 9 Stepper motors | no |
| Mechanical | |
| 10 Size LxWxH | mm 111 x 100 x 54 |
| CAN bus | |
| 11 Protocol | DS301 |
| 12 Device profile | DS402 |
| 13 Galvanically isolated | yes |
| EtherCAT | |
| 14 Type | EtherCAT Slave |
| 15 Physical layer | 100 Base-Tx EtherCAT |
| 16 Max. baudrate | 100 Mbit/s |
| 17 Number of ports | 2xRJ45 (In,Out) |
| 18 Protocol | CoE (CANopen over EtherCAT) |
| Incremental encoder | |
| 19 Input voltage (24VDC tolerant) | VDC 0..5 |
| 20 Signal type | differential, open collector, single ended |
| Hall sensors | |
| 21 Input voltage (24VDC tolerant) | VDC 0..5 |
| 22 Signal type | differential, open collector, single ended |
| Digital input | |
| 23 Number | 8 (Din0..7) |
| Digital output | |
| 24 Number | 2 (Dout0..1) |
| 25 Continuous output current | A 1.5 (Load: resistive, inductive) |
| Analog inputs | |
| 26 Number | 2 (Ain0..1) |
| 27 Signal type - Ain0 | +/- 10 VDC, 12 Bit, differential |
| 28 Signal type - Ain1 | +/- 10 VDC, 12 Bit, single ended |
| Environment | |
| 29 Operating temperature | °C -25...+70 |

Connection

| | | |
|---------------------------------|---------|---|
| X1 Motor | | |
| 1 | FE | Functional earth |
| 2 | +Up | Power supply voltage |
| 3 | GND | Ground for power supply voltage |
| 4 | Ma | Motor phase A |
| 5 | Mb | Motor phase B |
| 6 | Mc | Motor phase C |
| X2 Hall and inc. encoder | | |
| 1 | H1 | Hall sensor 1 |
| 2 | H2 | Hall sensor 2 |
| 3 | H3 | Hall sensor 3 |
| 4 | A | Inc. encoder, A channel |
| 5 | B | Inc. encoder, B channel |
| 6 | Inx | Inc. encoder, index channel |
| 7 | +U5V | 5V output voltage for sensor supply Sensors: encoder, hall |
| 8 | /H1 | Hall sensor 1 inverted |
| 9 | /H2 | Hall sensor 2 inverted |
| 10 | /H3 | Hall sensor 3 inverted |
| 11 | /A | Inc. encoder, A channel invert |
| 12 | /B | Inc. encoder, B channel inverted |
| 13 | /Inx | Inc. encoder, index channel inverted |
| 14 | GND | Ground for sensor supply (don't connect with system GND) |
| X3 I/O's and CAN | | |
| 1 | +Ue24V | Electronic supply voltage |
| 2 | +Ain0 | Analog input 0, positive |
| 3 | Din0 | Digital input 0 |
| 4 | Din1 | Digital input 1 |
| 5 | Din2 | Digital input 2 |
| 6 | Din3 | Digital input 3 |
| 7 | GND | Ground for electronic supply voltage |
| 8 | -Ain0 | Analog input 0, negative |
| 9 | Dout0 | Digital output 0 |
| 10 | CAN Hi | CAN High |
| 11 | CAN Lo | CAN Low |
| 12 | CAN GND | CAN Ground |
| X4 I/O's | | |
| 1 | Ain1 | Analog input 1 |
| 2 | Din4 | Digital input 4 |
| 3 | Din5 | Digital input 5 |
| 4 | Din6 | Digital input 6 |
| 5 | Dout1 | Digital output 1 |
| 6 | Din7 | Digital input 7 |
| X5 EtherCAT - In port | | |
| X6 EtherCAT - Out port | | |

SVTE-A-E40-CanOpen Servo Drives

60VDC | 10A
DC motors, BLDC motors

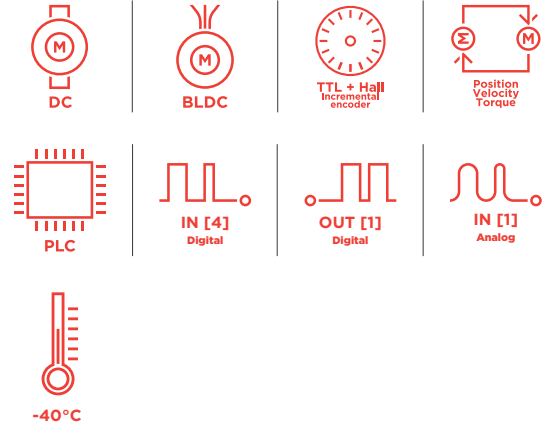
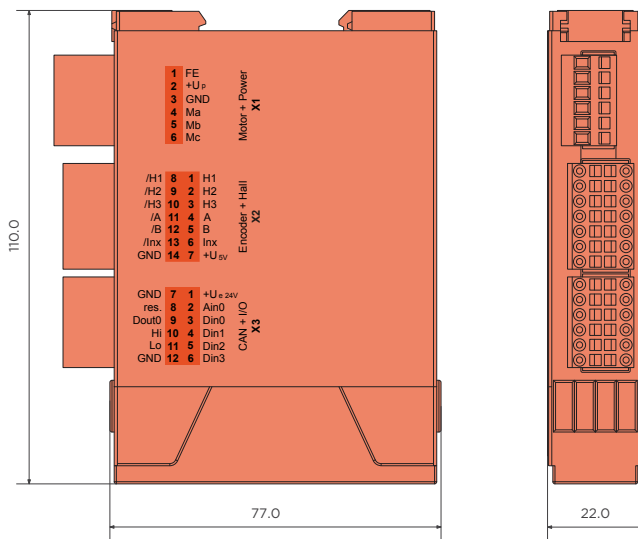

CANopen

| Values | Unit |
|---|--|
| Power | |
| 1 Electronic supply voltage U _e | VDC 9..30 |
| 2 Power supply voltage U _p | VDC 9..60 |
| 3 Max. output current | A 30 |
| 4 Continuous output current @ U _p =24VDC | A 10 |
| 5 Continuous output current @ U _p =48VDC | A 8.5 |
| 6 Output voltage | Up to 90% |
| Motor types | |
| 7 DC motors | yes |
| 8 BLDC motors | yes |
| 9 Stepper motors | no |
| Mechanical | |
| 10 Size LxWxH | mm 110 x 22.5 x 77 |
| CAN bus | |
| 11 Protocol | DS301 |
| 12 Device profile | DS402 |
| 13 Galvanically isolated | yes |
| Incremental encoder | |
| 14 Input voltage (24VDC tolerant) | VDC 0..5 |
| 15 Signal type | differential, open collector, single ended |
| Hall sensors | |
| 16 Input voltage (24VDC tolerant) | VDC 0..5 |
| 17 Signal type | differential, open collector, single ended |
| Digital input | |
| 18 Number | 4 (Din0..3) |
| Digital output | |
| 19 Number | 1 (Dout0..1) |
| 20 Continuous output current | A 1.5 (Load: resistive, inductive) |
| Analog inputs | |
| 21 Number | 1 (Ain0..1) |
| 22 Signal type | 0..10 VDC, 12 Bit, single ended |
| Environment | |
| 23 Operating temperature | °C -40...+70 |

Connection

| X1 Motor | | |
|--------------------------|---------|--|
| 1 | FE | Functional earth |
| 2 | +Up | Power supply voltage |
| 3 | GND | Ground for power supply voltage |
| 4 | Ma | Motor phase A |
| 5 | Mb | Motor phase B |
| 6 | Mc | Motor phase C |
| X2 Hall and inc. encoder | | |
| 1 | H1 | Hall sensor 1 |
| 2 | H2 | Hall sensor 2 |
| 3 | H3 | Hall sensor 3 |
| 4 | A | Inc. encoder, A channel |
| 5 | B | Inc. encoder, B channel |
| 6 | Inx | Inc. encoder, index channel |
| 7 | +U5V | 5V output voltage for sensor supply |
| | | Sensors: encoder, hall |
| 8 | /H1 | Hall sensor 1 inverted |
| 9 | /H2 | Hall sensor 2 inverted |
| 10 | /H3 | Hall sensor 3 inverted |
| 11 | /A | Inc. encoder, A channel invert |
| 12 | /B | Inc. encoder, B channel inverted |
| 13 | /Inx | Inc. encoder, index channel inverted |
| 14 | GND | Ground for sensor supply (don't connect with system GND) |
| X3 I/O's and CAN | | |
| 1 | +Ue24V | Electronic supply voltage |
| 2 | Ain0 | Analog input 0 |
| 3 | Din0 | Digital input 0 |
| 4 | Din1 | Digital input 1 |
| 5 | Din2 | Digital input 2 |
| 6 | Din3 | Digital input 3 |
| 7 | GND | Ground for electronic supply voltage |
| 8 | res. | Reserved |
| 9 | Dout0 | Digital output 0 |
| 10 | CAN Hi | CAN High |
| 11 | CAN Lo | CAN Low |
| 12 | CAN GND | CAN Ground |

SVTE-A-E40-EtherCAT Servo Drives

60VDC | 10A
DC motors, BLDC motors

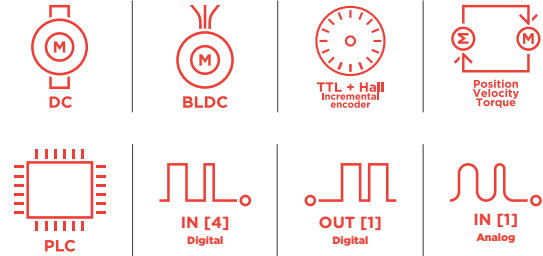
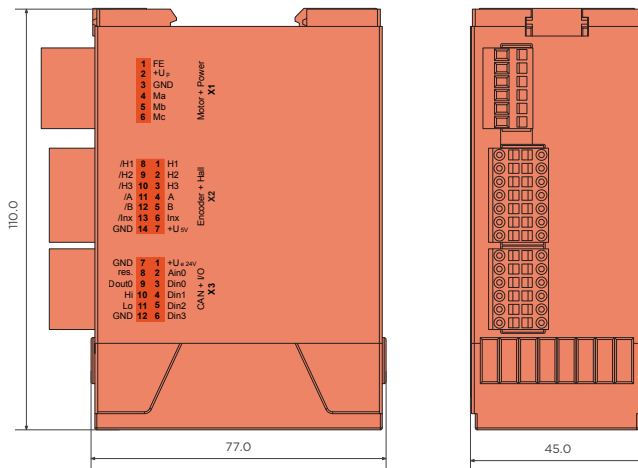

CANopen | EtherCAT

| Values | Unit |
|---|--|
| Power | |
| 1 Electronic supply voltage U _e | VDC 9..30 |
| 2 Power supply voltage U _p | VDC 9..60 |
| 3 Max. output current | A 30 |
| 4 Continuous output current @ U _p =24VDC | A 10 |
| 5 Continuous output current @ U _p =48VDC | A 8.5 |
| 6 Output voltage | Up to 90% |
| Motor types | |
| 7 DC motors | yes |
| 8 BLDC motors | yes |
| 9 Stepper motors | no |
| Mechanical | |
| 10 Size LxWxH | mm 110 x 45 x 77 |
| CAN bus | |
| 11 Protocol | DS301 |
| 12 Device profile | DS402 |
| 13 Galvanically isolated | no |
| EtherCAT | |
| 14 Type | EtherCAT Slave |
| 15 Physical layer | 100 Base-Tx EtherCAT |
| 16 Max. baudrate | 100 Mbit/s |
| 17 Number of ports | 2xRJ45 (In,Out) |
| 18 Protocol | CoE (CANopen over EtherCAT) |
| Incremental encoder | |
| 19 Input voltage (24VDC tolerant) | VDC 0..5 |
| 20 Signal type | differential, open collector, single ended |
| Hall sensors | |
| 21 Input voltage (24VDC tolerant) | VDC 0..5 |
| 22 Signal type | differential, open collector, single ended |
| Digital input | |
| 23 Number | 4 (Din0..3) |
| Digital output | |
| 24 Number | 1 (Dout0..1) |
| 25 Continuous output current | A 1.5 (Load: resistive, inductive) |
| Analog inputs | |
| 26 Number | 1 (Ain0..1) |
| 27 Signal type - Ain0 | 0..10 VDC, 12 Bit, single ended |
| Environment | |
| 28 Operating temperature | °C -25...+70 |

Connection

| X1 Motor | | |
|--------------------------|---------|---|
| 1 | FE | Functional earth |
| 2 | +Up | Power supply voltage |
| 3 | GND | Ground for power supply voltage |
| 4 | Ma | Motor phase A |
| 5 | Mb | Motor phase B |
| 6 | Mc | Motor phase C |
| X2 Hall and inc. encoder | | |
| 1 | H1 | Hall sensor 1 |
| 2 | H2 | Hall sensor 2 |
| 3 | H3 | Hall sensor 3 |
| 4 | A | Inc. encoder, A channel |
| 5 | B | Inc. encoder, B channel |
| 6 | Inx | Inc. encoder, index channel |
| 7 | +U5V | 5V output voltage for sensor supply Sensors: encoder, hall |
| 8 | /H1 | Hall sensor 1 inverted |
| 9 | /H2 | Hall sensor 2 inverted |
| 10 | /H3 | Hall sensor 3 inverted |
| 11 | /A | Inc. encoder, A channel invert |
| 12 | /B | Inc. encoder, B channel inverted |
| 13 | /Inx | Inc. encoder, index channel inverted |
| 14 | GND | Ground for sensor supply (don't connect with system GND) |
| X3 I/O's and CAN | | |
| 1 | +Ue24V | Electronic supply voltage |
| 2 | Ain0 | Analog input 0 |
| 3 | Din0 | Digital input 0 |
| 4 | Din1 | Digital input 1 |
| 5 | Din2 | Digital input 2 |
| 6 | Din3 | Digital input 3 |
| 7 | GND | Ground for electronic supply voltage |
| 8 | res. | Reserved |
| 9 | Dout0 | Digital output 0 |
| 10 | CAN Hi | CAN High |
| 11 | CAN Lo | CAN Low |
| 12 | CAN GND | CAN Ground |
| X5 EtherCAT - In port | | |
| X6 EtherCAT - Out port | | |

SVTE-A-E45-CanOpen Servo Drives

60VDC | 10A
DC motors, BLDC motors

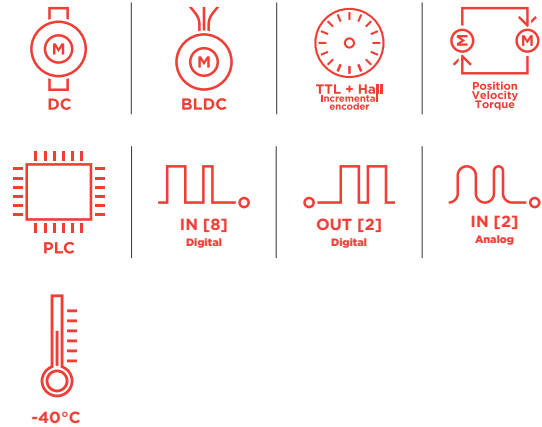
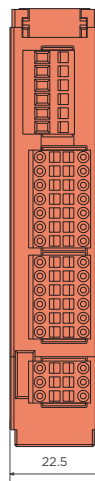
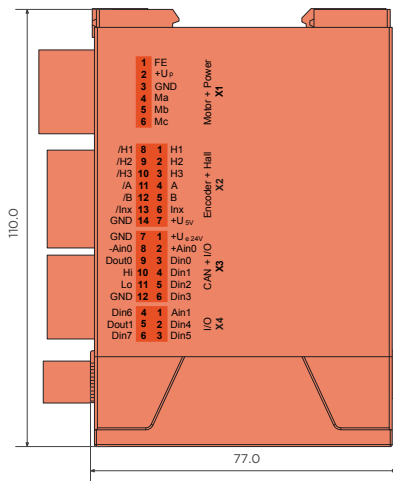

CANopen

| Values | Unit |
|---|--|
| Power | |
| 1 Electronic supply voltage U _e | VDC 9..30 |
| 2 Power supply voltage U _p | VDC 9..60 |
| 3 Max. output current | A 50 |
| 4 Continuous output current @ U _p =24VDC | A 10 |
| 5 Continuous output current @ U _p =48VDC | A 8.5 |
| 6 Output voltage | Up to 100% |
| Motor types | |
| 7 DC motors | yes |
| 8 BLDC motors | yes |
| 9 Stepper motors | no |
| Mechanical | |
| 10 Size LxWxH | mm 110 x 22.5 x 77 |
| CAN bus | |
| 11 Protocol | DS301 |
| 12 Device profile | DS402 |
| 13 Galvanically isolated | no |
| Incremental encoder | |
| 14 Input voltage (24VDC tolerant) | V 0..5 |
| 15 Signal type | differential, open collector, single ended |
| Hall sensors | |
| 16 Input voltage (24VDC tolerant) | V 0..5 |
| 17 Signal type | differential, open collector, single ended |
| Digital input | |
| 18 Number | 8 (Din0..7) |
| Digital output | |
| 19 Number | 2 (Dout0..1) |
| 20 Continuous output current | A 1.5 (Load: resistive, inductive) |
| Analog inputs | |
| 21 Number | 2 (Ain0..1) |
| 22 Signal type - Ain0 | +/- 10 VDC, 12 Bit, differential |
| 23 Signal type - Ain1 | +/- 10 VDC, 12 Bit, single ended |
| Environment | |
| 24 Operating temperature | °C -40...+70 |

Connection

| X1 Motor | | |
|--------------------------|---------|---|
| 1 | FE | Functional earth |
| 2 | +Up | Power supply voltage |
| 3 | GND | Ground for power supply voltage |
| 4 | Ma | Motor phase A |
| 5 | Mb | Motor phase B |
| 6 | Mc | Motor phase C |
| X2 Hall and inc. encoder | | |
| 1 | H1 | Hall sensor 1 |
| 2 | H2 | Hall sensor 2 |
| 3 | H3 | Hall sensor 3 |
| 4 | A | Inc. encoder, A channel |
| 5 | B | Inc. encoder, B channel |
| 6 | Inx | Inc. encoder, index channel |
| 7 | +U5V | 5V output voltage for sensor supply Sensors: encoder, hall |
| 8 | /H1 | Hall sensor 1 inverted |
| 9 | /H2 | Hall sensor 2 inverted |
| 10 | /H3 | Hall sensor 3 inverted |
| 11 | /A | Inc. encoder, A channel invert |
| 12 | /B | Inc. encoder, B channel inverted |
| 13 | /Inx | Inc. encoder, index channel inverted |
| 14 | GND | Ground for sensor supply (don't connect with system GND) |
| X3 I/O's and CAN | | |
| 1 | +Ue24V | Electronic supply voltage |
| 2 | +Ain0 | Analog input 0, positive |
| 3 | Din0 | Digital input 0 |
| 4 | Din1 | Digital input 1 |
| 5 | Din2 | Digital input 2 |
| 6 | Din3 | Digital input 3 |
| 7 | GND | Ground for electronic supply voltage |
| 8 | -Ain0 | Analog input 0, negative |
| 9 | Dout0 | Digital output 0 |
| 10 | CAN Hi | CAN High |
| 11 | CAN Lo | CAN Low |
| 12 | CAN GND | CAN Ground |
| X4 I/O's | | |
| 1 | Ain1 | Analog input 1 |
| 2 | Din4 | Digital input 4 |
| 3 | Din5 | Digital input 5 |
| 4 | Din6 | Digital input 6 |
| 5 | Dout1 | Digital output 1 |
| 6 | Din7 | Digital input 7 |

SVTE-A-E45-EtherCAT Servo Drives

60VDC | 10A
DC motors, BLDC motors

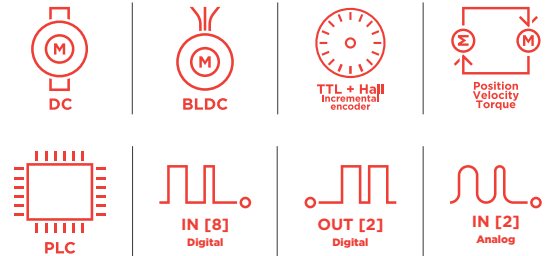
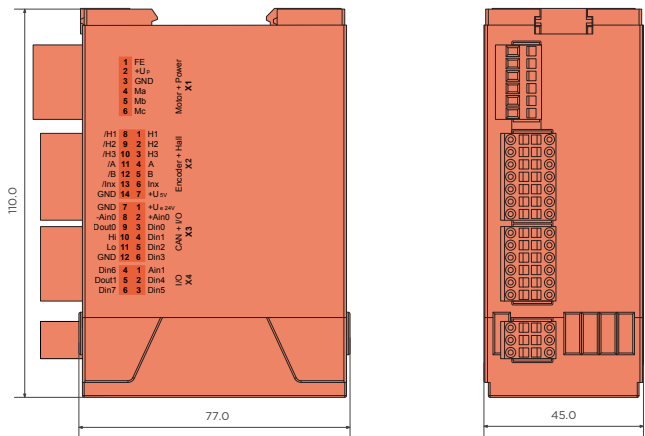

CANopen | EtherCAT

| Values | Unit |
|--|--|
| Power | |
| 1 Electronic supply voltage Ue | VDC 9..30 |
| 2 Power supply voltage Up | VDC 9..60 |
| 3 Max. output current | A 50 |
| 4 Continuous output current @ Up=24VDC | A 10 |
| 5 Continuous output current @ Up=48VDC | A 8.5 |
| 6 Output voltage | Up to 100% |
| Motor types | |
| 7 DC motors | yes |
| 8 BLDC motors | yes |
| 9 Stepper motors | no |
| Mechanical | |
| 10 Size LxWxH | mm 110 x 45 x 77 |
| CAN bus | |
| 11 Protocol | DS301 |
| 12 Device profile | DS402 |
| 13 Galvanically isolated | no |
| EtherCAT | |
| 14 Type | EtherCAT Slave |
| 15 Physical layer | 100 Base-Tx EtherCAT |
| 16 Max. baudrate | 100 Mbit/s |
| 17 Number of ports | 2xRJ45 (In,Out) |
| 18 Protocol | CoE (CANopen over EtherCAT) |
| Incremental encoder | |
| 19 Input voltage (24VDC tolerant) | VDC 0..5 |
| 20 Signal type | differential, open collector, single ended |
| Hall sensors | |
| 21 Input voltage (24VDC tolerant) | VDC 0..5 |
| 22 Signal type | differential, open collector, single ended |
| Digital input | |
| 23 Number | 8 (Din0..7) |
| Digital output | |
| 24 Number | 2 (Dout0..1) |
| 25 Continuous output current | A 1.5 (Load: resistive, inductive) |
| Analog inputs | |
| 26 Number | 2 (Ain0..1) |
| 27 Signal type - Ain0 | +/- 10 VDC, 12 Bit, differential |
| 28 Signal type - Ain1 | +/- 10 VDC, 12 Bit, single ended |
| Environment | |
| 29 Operating temperature | °C -25...+70 |

Connection

| | | |
|---------------------------------|---------|---|
| X1 Motor | | |
| 1 | FE | Functional earth |
| 2 | +Up | Power supply voltage |
| 3 | GND | Ground for power supply voltage |
| 4 | Ma | Motor phase A |
| 5 | Mb | Motor phase B |
| 6 | Mc | Motor phase C |
| X2 Hall and inc. encoder | | |
| 1 | H1 | Hall sensor 1 |
| 2 | H2 | Hall sensor 2 |
| 3 | H3 | Hall sensor 3 |
| 4 | A | Inc. encoder, A channel |
| 5 | B | Inc. encoder, B channel |
| 6 | Inx | Inc. encoder, index channel |
| 7 | +U5V | 5V output voltage for sensor supply Sensors: encoder, hall |
| 8 | /H1 | Hall sensor 1 inverted |
| 9 | /H2 | Hall sensor 2 inverted |
| 10 | /H3 | Hall sensor 3 inverted |
| 11 | /A | Inc. encoder, A channel invert |
| 12 | /B | Inc. encoder, B channel inverted |
| 13 | /Inx | Inc. encoder, index channel inverted |
| 14 | GND | Ground for sensor supply (don't connect with system GND) |
| X3 I/O's and CAN | | |
| 1 | +Ue24V | Electronic supply voltage |
| 2 | +Ain0 | Analog input 0, positive |
| 3 | Din0 | Digital input 0 |
| 4 | Din1 | Digital input 1 |
| 5 | Din2 | Digital input 2 |
| 6 | Din3 | Digital input 3 |
| 7 | GND | Ground for electronic supply voltage |
| 8 | -Ain0 | Analog input 0, negative |
| 9 | Dout0 | Digital output 0 |
| 10 | CAN Hi | CAN High |
| 11 | CAN Lo | CAN Low |
| 12 | CAN GND | CAN Ground |
| X4 I/O's | | |
| 1 | Ain1 | Analog input 1 |
| 2 | Din4 | Digital input 4 |
| 3 | Din5 | Digital input 5 |
| 4 | Din6 | Digital input 6 |
| 5 | Dout1 | Digital output 1 |
| 6 | Din7 | Digital input 7 |
| X5 EtherCAT - In port | | |
| X6 EtherCAT - Out port | | |

SVTE-A-E45-Profinet Servo Drives

60VDC | 10A
DC motors, BLDC motors

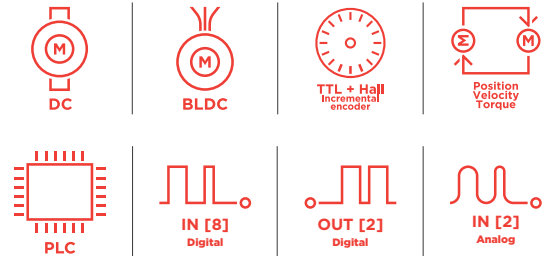
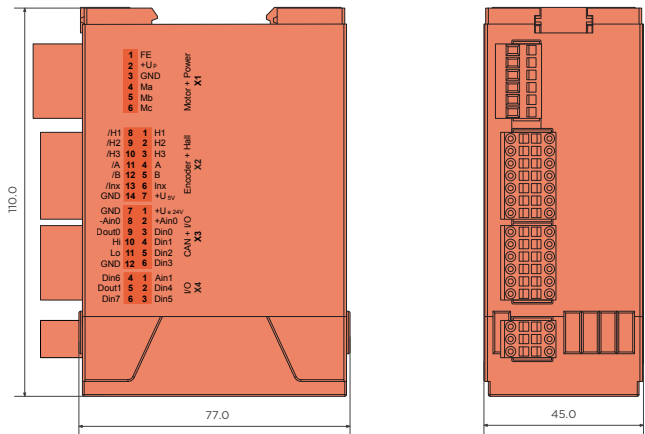

CANopen | PROFIBUS NET

| Values | Unit |
|--|--|
| Power | |
| 1 Electronic supply voltage Ue | VDC 9..30 |
| 2 Power supply voltage Up | VDC 9..60 |
| 3 Max. output current | A 50 |
| 4 Continuous output current @ Up=24VDC | A 10 |
| 5 Continuous output current @ Up=48VDC | A 8.5 |
| 6 Output voltage | Up to 100% |
| Motor types | |
| 7 DC motors | yes |
| 8 BLDC motors | yes |
| 9 Stepper motors | no |
| Mechanical | |
| 10 Size LxWxH | mm 110 x 45 x 77 |
| CAN bus | |
| 11 Protocol | DS301 |
| 12 Device profile | DS402 |
| 13 Galvanically isolated | no |
| Profinet | |
| 14 Type | Slave |
| 15 Physical layer | 100 Base-Tx |
| 16 Max. baudrate | 100 Mbit/s |
| 17 Number of ports | 2xRJ45 (PORT1,PORT2) |
| Incremental encoder | |
| 18 Input voltage (24VDC tolerant) | VDC 0..5 |
| 19 Signal type | differential, open collector, single ended |
| Hall sensors | |
| 20 Input voltage (24VDC tolerant) | VDC 0..5 |
| 21 Signal type | differential, open collector, single ended |
| Digital input | |
| 22 Number | 8 (Din0..7) |
| Digital output | |
| 23 Number | 2 (Dout0..1) |
| 24 Continuous output current | A 1.5 (Load: resistive, inductive) |
| Analog inputs | |
| 25 Number | 2 (Ain0..1) |
| 26 Signal type - Ain0 | +/- 10 Vdc, 12 Bit, differential |
| 27 Signal type - Ain1 | +/- 10 Vdc, 12 Bit, single ended |
| Environment | |
| 28 Operating temperature | °C -25...+40 |

Connection

| | | |
|---------------------------------|---------|---|
| X1 Motor | | |
| 1 | FE | Functional earth |
| 2 | +Up | Power supply voltage |
| 3 | GND | Ground for power supply voltage |
| 4 | Ma | Motor phase A |
| 5 | Mb | Motor phase B |
| 6 | Mc | Motor phase C |
| X2 Hall and inc. encoder | | |
| 1 | H1 | Hall sensor 1 |
| 2 | H2 | Hall sensor 2 |
| 3 | H3 | Hall sensor 3 |
| 4 | A | Inc. encoder, A channel |
| 5 | B | Inc. encoder, B channel |
| 6 | Inx | Inc. encoder, index channel |
| 7 | +U5V | 5V output voltage for sensor supply Sensors: encoder, hall |
| 8 | /H1 | Hall sensor 1 inverted |
| 9 | /H2 | Hall sensor 2 inverted |
| 10 | /H3 | Hall sensor 3 inverted |
| 11 | /A | Inc. encoder, A channel invert |
| 12 | /B | Inc. encoder, B channel inverted |
| 13 | /Inx | Inc. encoder, index channel inverted |
| 14 | GND | Ground for sensor supply (don't connect with system GND) |
| X3 I/O's and CAN | | |
| 1 | +Ue24V | Electronic supply voltage |
| 2 | +Ain0 | Analog input 0, positive |
| 3 | Din0 | Digital input 0 |
| 4 | Din1 | Digital input 1 |
| 5 | Din2 | Digital input 2 |
| 6 | Din3 | Digital input 3 |
| 7 | GND | Ground for electronic supply voltage |
| 8 | -Ain0 | Analog input 0, negative |
| 9 | Dout0 | Digital output 0 |
| 10 | CAN Hi | CAN High |
| 11 | CAN Lo | CAN Low |
| 12 | CAN GND | CAN Ground |
| X4 I/O's | | |
| 1 | Ain1 | Analog input 1 |
| 2 | Din4 | Digital input 4 |
| 3 | Din5 | Digital input 5 |
| 4 | Din6 | Digital input 6 |
| 5 | Dout1 | Digital output 1 |
| 6 | Din7 | Digital input 7 |
| X5 Profinet - PORT1 | | |
| X6 Profinet - PORT2 | | |

SVTE-A-E47-CanOpen Servo Drives

60VDC | 10A
DC motors, BLDC motors

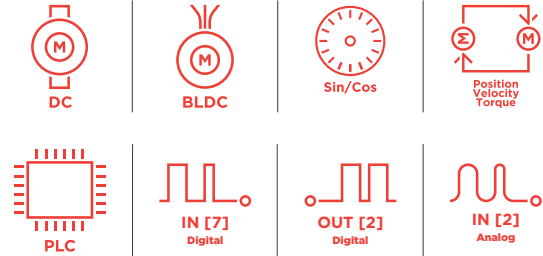
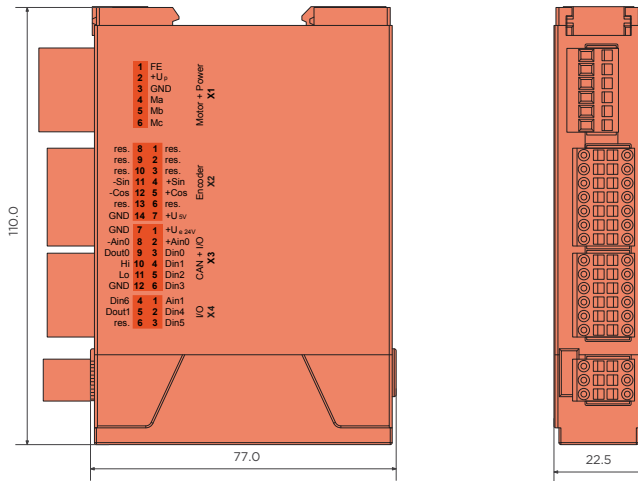

CANopen

| Values | Unit |
|--|------------------------------------|
| Power | |
| 1 Electronic supply voltage Ue | VDC 9..30 |
| 2 Power supply voltage Up | VDC 9..60 |
| 3 Max. output current | A 50 |
| 4 Continuous output current @ Up=24VDC | A 10 |
| 5 Continuous output current @ Up=48VDC | A 8.5 |
| 6 Output voltage | Up to 100% |
| Motor types | |
| 7 DC motors | yes |
| 8 BLDC motors | yes |
| 9 Stepper motors | no |
| Mechanical | |
| 10 Size LxWxH | mm 110 x 22.5 x 77 |
| CAN bus | |
| 11 Protocol | DS301 |
| 12 Device profile | DS402 |
| 13 Galvanically isolated | no |
| Encoder | |
| 14 Input voltage | VDC 1 V peak-peak, differential |
| 15 Signal type | sin / cos, analog, differential |
| 16 Resolution | 13 bit per sine period |
| Digital input | |
| 17 Number | 7 (Din0..6) |
| Digital output | |
| 18 Number | 2 (Dout0..1) |
| 19 Continuous output current | A 1.5 (Load: resistive, inductive) |
| Analog inputs | |
| 20 Number | 2 (Ain0..1) |
| 21 Signal type - Ain0 | +/- 10 Vdc, 12 Bit, differential |
| 22 Signal type - Ain1 | +/- 10 Vdc, 12 Bit, single ended |
| Environment | |
| 23 Operating temperature | °C -40...+70 |

Connection

| X1 Motor | | |
|--------------------|---------|---|
| 1 | FE | Functional earth |
| 2 | +Up | Power supply voltage |
| 3 | GND | Ground for power supply voltage |
| 4 | Ma | Motor phase A |
| 5 | Mb | Motor phase B |
| 6 | Mc | Motor phase C |
| X2 Encoder sin/cos | | |
| 1 | res. | Reserved |
| 2 | res. | Reserved |
| 3 | res. | Reserved |
| 4 | +Sin | Sine + signal |
| 5 | +Cos | Cosine + signal |
| 6 | res. | Reserved |
| 7 | +U5V | 5V output voltage for sensor supply Sensors: encoder |
| 8 | res. | Reserved |
| 9 | res. | Reserved |
| 10 | res. | Reserved |
| 11 | -Sin | Sine - signal |
| 12 | -Cos | Cosine - signal |
| 13 | res. | Reserved |
| 14 | GND | Ground for sensor supply Notice: don't connect with system GND |
| X3 I/O's and CAN | | |
| 1 | +Ue24V | Electronic supply voltage |
| 2 | +Ain0 | Analog input 0, positive |
| 3 | Din0 | Digital input 0 |
| 4 | Din1 | Digital input 1 |
| 5 | Din2 | Digital input 2 |
| 6 | Din3 | Digital input 3 |
| 7 | GND | Ground for electronic supply voltage |
| 8 | -Ain0 | Analog input 0, negative |
| 9 | Dout0 | Digital output 0 |
| 10 | CAN Hi | CAN High |
| 11 | CAN Lo | CAN Low |
| 12 | CAN GND | CAN Ground |
| X4 I/O's | | |
| 1 | Ain1 | Analog input 1 |
| 2 | Din4 | Digital input 4 |
| 3 | Din5 | Digital input 5 |
| 4 | Din6 | Digital input 6 |
| 5 | Dout1 | Digital output 1 |
| 6 | res. | Reserved |

SVTE-A-E47-EtherCAT Servo Drives

60VDC | 10A
DC motors, BLDC motors

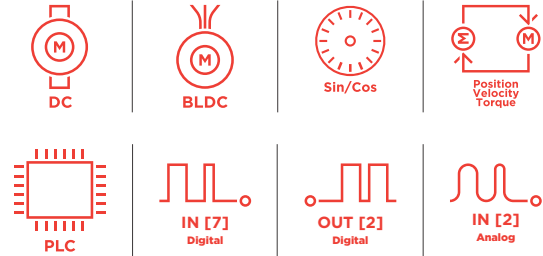
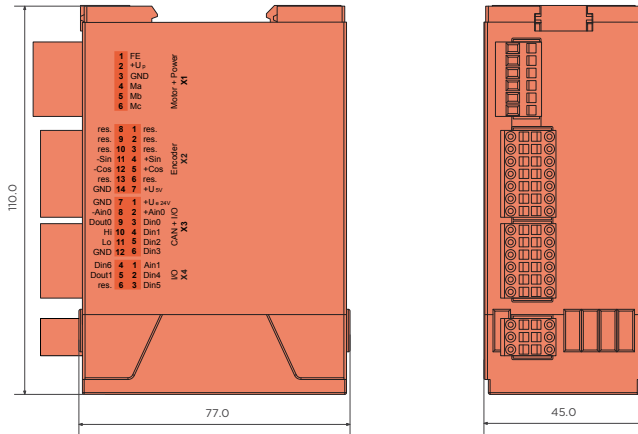

CANopen | EtherCAT

| Values | Unit |
|--|------------------------------------|
| Power | |
| 1 Electronic supply voltage Ue | VDC 9..30 |
| 2 Power supply voltage Up | VDC 9..60 |
| 3 Max. output current | A 50 |
| 4 Continuous output current @ Up=24VDC | A 10 |
| 5 Continuous output current @ Up=48VDC | A 8.5 |
| 6 Output voltage | Up to 100% |
| Motor types | |
| 7 DC motors | yes |
| 8 BLDC motors | yes |
| 9 Stepper motors | no |
| Mechanical | |
| 10 Size LxWxH | mm 110 x 45 x 77 |
| CAN bus | |
| 11 Protocol | DS301 |
| 12 Device profile | DS402 |
| 13 Galvanically isolated | no |
| EtherCAT | |
| 14 Type | EtherCAT Slave |
| 15 Physical layer | 100 Base-Tx EtherCAT |
| 16 Max. baudrate | 100 Mbit/s |
| 17 Number of ports | 2xRJ45 (In,Out) |
| 18 Protocol | CoE (CANopen over EtherCAT) |
| Encoder | |
| 19 Input voltage | sin / cos |
| 20 Signal type | 1 Vdc peak-peak, differential |
| 21 Resolution | 13 bit per sine period |
| Digital input | |
| 22 Number | 7 (Din0..6) |
| Digital output | |
| 23 Number | 2 (Dout0..1) |
| 24 Continuous output current | A 1.5 (Load: resistive, inductive) |
| Analog inputs | |
| 25 Number | 2 (Ain0..1) |
| 26 Signal type - Ain0 | +/- 10 Vdc, 12 Bit, differential |
| 27 Signal type - Ain1 | +/- 10 Vdc, 12 Bit, single ended |
| Environment | |
| 28 Operating temperature | °C -25...+70 |

Connection

| | | |
|----------------------------|---------|--|
| X1 Motor | | |
| 1 | FE | Functional earth |
| 2 | +Up | Power supply voltage |
| 3 | GND | Ground for power supply voltage |
| 4 | Ma | Motor phase A |
| 5 | Mb | Motor phase B |
| 6 | Mc | Motor phase C |
| X2 Encoder sin/cos | | |
| 1 | res. | Reserved |
| 2 | res. | Reserved |
| 3 | res. | Reserved |
| 4 | +Sin | Sine + signal |
| 5 | +Cos | Cosine + signal |
| 6 | res. | Reserved |
| 7 | +U5V | 5V output voltage for sensor supply Sensors: encoder |
| 8 | res. | Reserved |
| 9 | res. | Reserved |
| 10 | res. | Reserved |
| 11 | -Sin | Sine - signal |
| 12 | -Cos | Cosine - signal |
| 13 | res. | Reserved |
| 14 | GND | Ground for sensor supply (don't connect with system GND) |
| X3 I/O's and CAN | | |
| 1 | +Ue24V | Electronic supply voltage |
| 2 | +Ain0 | Analog input 0, positive |
| 3 | Din0 | Digital input 0 |
| 4 | Din1 | Digital input 1 |
| 5 | Din2 | Digital input 2 |
| 6 | Din3 | Digital input 3 |
| 7 | GND | Ground for electronic supply voltage |
| 8 | -Ain0 | Analog input 0, negative |
| 9 | Dout0 | Digital output 0 |
| 10 | CAN Hi | CAN High |
| 11 | CAN Lo | CAN Low |
| 12 | CAN GND | CAN Ground |
| X4 I/O's | | |
| 1 | Ain1 | Analog input 1 |
| 2 | Din4 | Digital input 4 |
| 3 | Din5 | Digital input 5 |
| 4 | Din6 | Digital input 6 |
| 5 | Dout1 | Digital output 1 |
| 6 | res. | Reserved |
| X5 EtherCAT - PORT1 | | |
| X6 EtherCAT - PORT2 | | |

SVTE-A-E50-CanOpen Servo Drives

60VDC | 7.5A
DC motors, BLDC motors

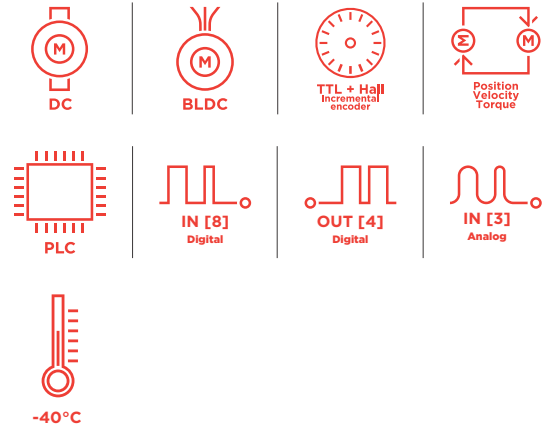
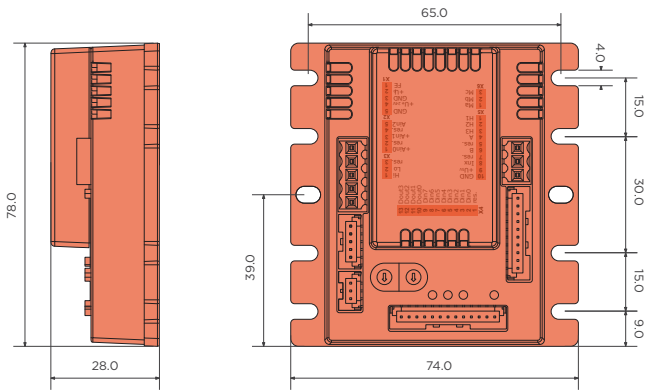

CANopen

| Values | Unit |
|--|------------------------------------|
| Power | |
| 1 Electronic supply voltage U _e | VDC 9..30 |
| 2 Power supply voltage U _p | VDC 9..60 |
| 3 Max. output current | A 25 |
| 4 Continuous output current @ U _p =24VDC (certified UL) | A 7.5 |
| 5 Continuous output current @ U _p =60VDC (certified UL) | A 7 |
| 6 Output voltage | Up to 90% |
| Motor types | |
| 7 DC motors | Yes |
| 8 BLDC motors | Yes |
| 9 Stepper motors | No |
| Mechanical | |
| 10 Size LxWxH | mm 78 x 74 x 28 |
| CAN bus | |
| 11 Protocol | DS301 |
| 12 Device profile | DS402 |
| 13 Galvanically isolated | no |
| Incremental encoder | |
| 14 Input voltage | VDC 0..5 |
| 15 Signal type | open collector, single ended |
| Hall sensors | |
| 16 Input voltage | VDC 0..5 |
| 17 Signal type | open collector, single ended |
| Digital input | |
| 18 Number | 8 (Din0..7) |
| Digital output | |
| 19 Number | 4 (Dout0..3) |
| 20 Continuous output current | A 0.3 (Load: resistive, inductive) |
| Analog inputs | |
| 21 Number | 3 (Ain0..2) |
| 22 Signal type - Ain0..1 | 0..10V, 12 Bit, Single Ended |
| 23 Signal type - Ain2 | 0..5V, 12 Bit, Single Ended |
| Environment | |
| 24 Operating temperature | °C -40..+70°C |

Connection

| | | |
|----------------------------------|--------|--|
| X1 Supply | | |
| 1 | FE | Functional earth |
| 2 | +Up | Power supply voltage |
| 3 | GND | Ground for power supply voltage |
| 4 | +Ue24V | Electronic supply voltage |
| 5 | GND | Ground for electronic supply voltage |
| X2 Analog Inputs | | |
| 1 | Ain0 | Analog input 0 |
| 2 | res. | Reserved |
| 3 | Ain1 | Analog input 1 |
| 4 | res. | Reserved |
| 5 | Ain2 | Analog Input 2 (5V) |
| X3 CAN bus | | |
| 1 | CAN Hi | CAN High |
| 2 | CAN Lo | CAN Low |
| 3 | res. | Reserved |
| X4 Digital inputs/outputs | | |
| 1 | res. | Reserved |
| 2 | Din0 | Digital input 0 |
| 3 | Din1 | Digital input 1 |
| 4 | Din2 | Digital input 2 |
| 5 | Din3 | Digital input 3 |
| 6 | Din4 | Digital input 4 |
| 7 | Din5 | Digital input 5 |
| 8 | Din6 | Digital input 6 |
| 9 | Din7 | Digital input 7 |
| 10 | Dout0 | Digital output 0 |
| 11 | Dout1 | Digital output 1 |
| 12 | Dout2 | Digital output 2 |
| 13 | Dout3 | Digital output 3 |
| X5 Hall and inc. encoder | | |
| 1 | H1 | Hall sensor 1 |
| 2 | H2 | Hall sensor 2 |
| 3 | H3 | Hall sensor 3 |
| 4 | A | Inc. encoder, A channel |
| 5 | res. | Reserved |
| 6 | B | Inc. encoder, B channel |
| 7 | res. | Reserved |
| 8 | Inx | Inc. encoder, index channel |
| 9 | +U5V | 5V output voltage for sensor supply |
| 10 | GND | Ground for sensor supply (don't connect with system GND) |
| X6 Motor | | |
| 1 | Ma | Motor phase A |
| 2 | Mb | Motor phase B |
| 3 | Mc | Motor phase C |

SVTE-A-E55-CanOpen Servo Drives

60VDC | 10A
DC motors, BLDC motors

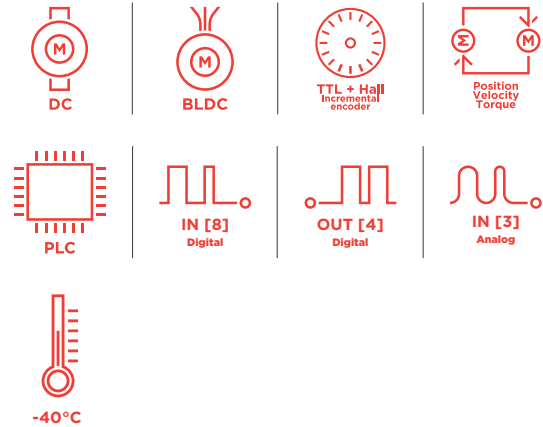
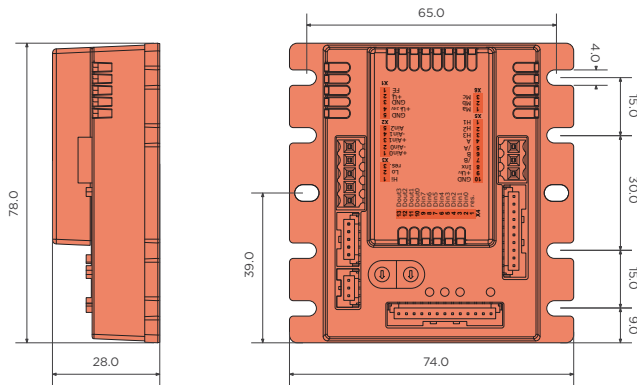

CANopen

| Values | Unit |
|--|--|
| Power | |
| 1 Electronic supply voltage Ue | VDC 9..30 |
| 2 Power supply voltage Up | VDC 9..60 |
| 3 Max. output current | A 50 |
| 4 Continuous output current @ Up=24VDC | A 10 |
| 5 Continuous output current @ Up=48VDC | A 8.5 |
| 6 Output voltage | Up to 100% |
| Motor types | |
| 7 DC motors | yes |
| 8 BLDC motors | yes |
| 9 Stepper motors | no |
| Mechanical | |
| 10 Size LxWxH | mm 78 x 74 x 28 |
| CAN bus | |
| 11 Protocol | DS301 |
| 12 Device profile | DS402 |
| 13 Galvanically isolated | no |
| Incremental encoder | |
| 14 Input voltage (24VDC tolerant) | VDC 0..5 |
| 15 Signal type | differential, open collector, single ended, 2,5 kOhm input impedance |
| Hall sensor | |
| 16 Input voltage | VDC 0..5 |
| 17 Signal type | open collector, single ended, 5VDC pull up intern 920 Ohm |
| Digital input | |
| 18 Number | 8 (Din0..7) |
| Digital output | |
| 19 Number | 4 (Dout0..3) |
| 20 Continuous output current | A 0.3 (Load: resistive, inductive) |
| Analog inputs | |
| 21 Number | 3 (Ain0..2) |
| 22 Signal type - Ain0..1 | +/- 10VDC, 12 Bit, differential, 200 kOhm input impedance |
| 23 Signal type - Ain2 | 0..5 VDC, 12 Bit, single ended, 5VDC pull up intern 1,5 kOhm |
| Environment | |
| 24 Operating temperature | °C -40...+70 |

Connection

| | | |
|----------------------------------|--------|--|
| X1 Supply | | |
| 1 | FE | Functional earth |
| 2 | +Up | Power supply voltage |
| 3 | GND | Ground for power supply voltage |
| 4 | +Ue24V | Electronic supply voltage |
| 5 | GND | Ground for electronic supply voltage |
| X2 Analog Inputs | | |
| 1 | +Ain0 | Analog input 0, positive |
| 2 | -Ain0 | Analog input 0, negative |
| 3 | +Ain1 | Analog input 1, positive |
| 4 | -Ain1 | Analog input 1, negative |
| 5 | Ain2 | Analog Input 2 (5V) |
| X3 CAN bus | | |
| 1 | CAN Hi | CAN High |
| 2 | CAN Lo | CAN Low |
| 3 | res. | Reserved |
| X4 Digital inputs/outputs | | |
| 1 | res. | Reserved |
| 2 | Din0 | Digital input 0 |
| 3 | Din1 | Digital input 1 |
| 4 | Din2 | Digital input 2 |
| 5 | Din3 | Digital input 3 |
| 6 | Din4 | Digital input 4 |
| 7 | Din5 | Digital input 5 |
| 8 | Din6 | Digital input 6 |
| 9 | Din7 | Digital input 7 |
| 10 | Dout0 | Digital output 0 |
| 11 | Dout1 | Digital output 1 |
| 12 | Dout2 | Digital output 2 |
| 13 | Dout3 | Digital output 3 |
| X5 Hall and inc. encoder | | |
| 1 | H1 | Hall sensor 1 |
| 2 | H2 | Hall sensor 2 |
| 3 | H3 | Hall sensor 3 |
| 4 | A | Inc. encoder, A channel |
| 5 | /A | Inc. encoder, A channel invert |
| 6 | B | Inc. encoder, B channel |
| 7 | /B | Inc. encoder, B channel inverted |
| 8 | Inx | Inc. encoder, index channel |
| 9 | +U5V | 5V output voltage for sensor supply |
| 10 | GND | Ground for sensor supply (don't connect with system GND) |
| X6 Motor | | |
| 1 | Ma | Motor phase A |
| 2 | Mb | Motor phase B |
| 3 | Mc | Motor phase C |

SVTE-A-E55-EtherCAT Servo Drives

60VDC | 8A
DC motors, BLDC motors

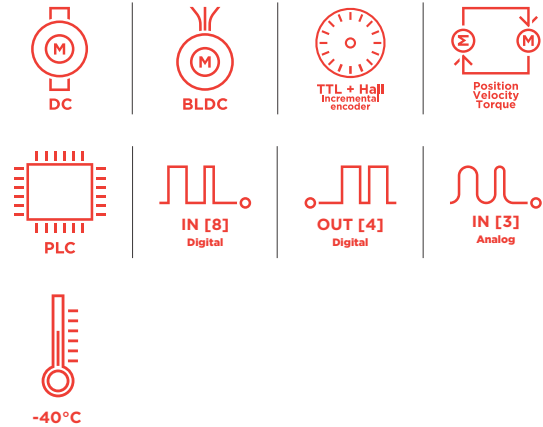
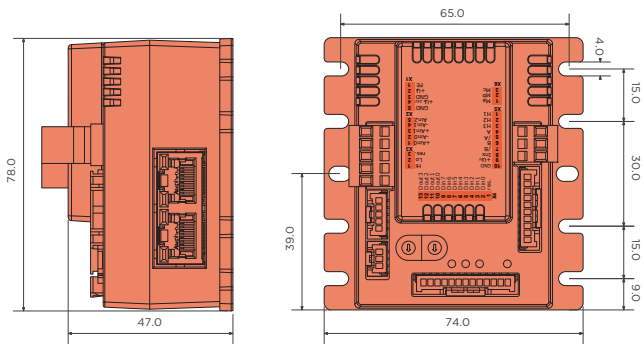

CANopen | EtherCAT

| Values | Unit |
|--|--|
| Power | |
| 1 Electronic supply voltage U _e | VDC 9..30 |
| 2 Power supply voltage U _p | VDC 9..60 |
| 3 Max. output current | A 50 |
| 4 Continuous output current | A 8 |
| 5 Output voltage | Up to 100% |
| Motor types | |
| 6 DC motors | yes |
| 7 BLDC motors | yes |
| 8 Stepper motors | no |
| Mechanical | |
| 9 Size LxWxH | mm 78x74x47 |
| CAN bus | |
| 10 Protocol | DS301 |
| 11 Device profile | DS402 |
| 12 Galvanically isolated | no |
| EtherCAT | |
| 13 Type | EtherCAT Slave |
| 14 Physical layer | 100 Base-Tx EtherCAT |
| 15 Max. baudrate | 100 Mbit/s |
| 16 Number of ports | 2xRJ45 (In,Out) |
| 17 Protocol | CoE (CANopen over EtherCAT) |
| Incremental encoder | |
| 18 Input voltage (24VDC tolerant) | 0..5 |
| 19 Signal type | differential, open collector, single ended |
| Hall sensors | |
| 20 Input voltage | 0..5 |
| 21 Signal type | open collector, single ended |
| Digital input | |
| 22 Number | 8 (Din0..7) |
| Digital output | |
| 23 Number | 4 (Dout0..3) |
| 24 Continuous output current | A 0.3 (Load: resistive, inductive) |
| Analog inputs | |
| 25 Number | 3 (Ain0..2) |
| 26 Signal type - Ain0..1 | +/- 10 VDC, 12 Bit, differential |
| 27 Signal type - Ain2 | 0..5VDC, 12 Bit, single ended |
| Environment | |
| 28 Operating temperature | °C -40...+70 |

Connection

| | | |
|----------------------------------|--------|--|
| X1 Supply | | |
| 1 | FE | Functional earth |
| 2 | +Up | Power supply voltage |
| 3 | GND | Ground for power supply voltage |
| 4 | +Ue24V | Electronic supply voltage |
| 5 | GND | Ground for electronic supply voltage |
| X2 Analog Inputs | | |
| 1 | +Ain0 | Analog input 0, positive |
| 2 | -Ain0 | Analog input 0, negative |
| 3 | +Ain1 | Analog input 1, positive |
| 4 | -Ain1 | Analog input 1, negative |
| 5 | Ain2 | Analog Input 2 (5V) |
| X3 CAN bus | | |
| 1 | CAN Hi | CAN High |
| 2 | CAN Lo | CAN Low |
| 3 | res. | Reserved |
| X4 Digital inputs/outputs | | |
| 1 | res. | Reserved |
| 2 | Din0 | Digital input 0 |
| 3 | Din1 | Digital input 1 |
| 4 | Din2 | Digital input 2 |
| 5 | Din3 | Digital input 3 |
| 6 | Din4 | Digital input 4 |
| 7 | Din5 | Digital input 5 |
| 8 | Din6 | Digital input 6 |
| 9 | Din7 | Digital input 7 |
| 10 | Dout0 | Digital output 0 |
| 11 | Dout1 | Digital output 1 |
| 12 | Dout2 | Digital output 2 |
| 13 | Dout3 | Digital output 3 |
| X5 Hall and inc. encoder | | |
| 1 | H1 | Hall sensor 1 |
| 2 | H2 | Hall sensor 2 |
| 3 | H3 | Hall sensor 3 |
| 4 | A | Inc. encoder, A channel |
| 5 | /A | Inc. encoder, A channel invert |
| 6 | B | Inc. encoder, B channel |
| 7 | /B | Inc. encoder, B channel inverted |
| 8 | Inx | Inc. encoder, index channel |
| 9 | +U5V | 5V output voltage for sensor supply |
| 10 | GND | Ground for sensor supply (don't connect with system GND) |
| X6 Motor | | |
| 1 | Ma | Motor phase A |
| 2 | Mb | Motor phase B |
| 3 | Mc | Motor phase C |
| X7 EtherCAT - In port | | |
| X8 EtherCAT - Out port | | |

SVTE-A-E55-Profinet Servo Drives

60VDC | 9A
DC motors, BLDC motors

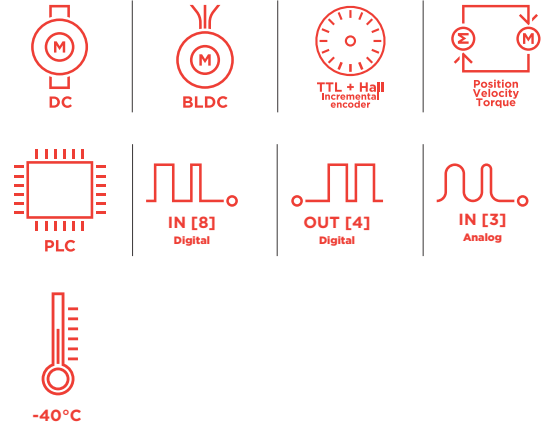
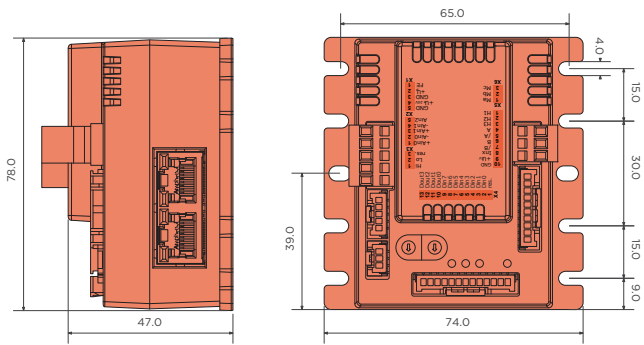

CANopen | PROFIBUS NET

| Values | Unit |
|--|--|
| Power | |
| 1 Electronic supply voltage Ue | VDC 9..30 |
| 2 Power supply voltage Up | VDC 9..60 |
| 3 Max. output current | A 50 |
| 4 Continuous output current @ Up=24VDC | A 9 |
| 5 Continuous output current @ Up=48VDC | A 8 |
| 6 Output voltage | Up to 100% |
| Motor types | |
| 7 DC motors | yes |
| 8 BLDC motors | yes |
| 9 Stepper motors | no |
| Mechanical | |
| 10 Size LxWxH | mm 78 x 74 x 47 |
| CAN bus | |
| 11 Protocol | DS301 |
| 12 Device profile | DS402 |
| 13 Galvanically isolated | no |
| Profinet | |
| 14 Type | Slave |
| 15 Physical layer | 100 Base-Tx |
| 16 Max. baudrate | 100 Mbit/s |
| 17 Number of ports | 2xRJ45 (PORT1, PORT2) |
| Incremental encoder | |
| 18 Input voltage (24VDC tolerant) | VDC 0..5 |
| 19 Signal type | differential, open collector, single ended, 2.5 kOhm input impedance |
| Hall sensors | |
| 20 Input voltage | VDC 0..5 |
| 21 Signal type | open collector, single ended, 5VDC pull up intern 920 Ohm |
| Digital input | |
| 22 Number | 8 (Din0..7) |
| Digital output | |
| 23 Number | 4 (Dout0..3) |
| 24 Continuous output current | A 0.3 (Load: resistive, inductive) |
| Analog inputs | |
| 25 Number | 3 (Ain0..2) |
| 26 Signal type - Ain0...1 | +/- 10 VDC, 12 Bit, differential, 20 kOhm input impedance |
| 27 Signal type - Ain2 | 0..5 VDC, 12 Bit, single ended, 5VDC pull up intern 1.5 kOhm |
| Environment | |
| 28 Operating temperature | °C -40...+70 |

Connection

| | | |
|----------------------------------|--------|--|
| X1 Supply | | |
| 1 | FE | Functional earth |
| 2 | +Up | Power supply voltage |
| 3 | GND | Ground for power supply voltage |
| 4 | +Ue24V | Electronic supply voltage |
| 5 | GND | Ground for electronic supply voltage |
| X2 Analog Inputs | | |
| 1 | +Ain0 | Analog input 0, positive |
| 2 | -Ain0 | Analog input 0, negative |
| 3 | +Ain1 | Analog input 1, positive |
| 4 | -Ain1 | Analog input 1, negative |
| 5 | Ain2 | Analog Input 2 (5V) |
| X3 CAN bus | | |
| 1 | CAN Hi | CAN High |
| 2 | CAN Lo | CAN Low |
| 3 | res. | Reserved |
| X4 Digital inputs/outputs | | |
| 1 | res. | Reserved |
| 2 | Din0 | Digital input 0 |
| 3 | Din1 | Digital input 1 |
| 4 | Din2 | Digital input 2 |
| 5 | Din3 | Digital input 3 |
| 6 | Din4 | Digital input 4 |
| 7 | Din5 | Digital input 5 |
| 8 | Din6 | Digital input 6 |
| 9 | Din7 | Digital input 7 |
| 10 | Dout0 | Digital output 0 |
| 11 | Dout1 | Digital output 1 |
| 12 | Dout2 | Digital output 2 |
| 13 | Dout3 | Digital output 3 |
| X5 Hall and inc. encoder | | |
| 1 | H1 | Hall sensor 1 |
| 2 | H2 | Hall sensor 2 |
| 3 | H3 | Hall sensor 3 |
| 4 | A | Inc. encoder, A channel |
| 5 | /A | Inc. encoder, A channel invert |
| 6 | B | Inc. encoder, B channel |
| 7 | /B | Inc. encoder, B channel inverted |
| 8 | Inx | Inc. encoder, index channel |
| 9 | +U5V | 5V output voltage for sensor supply |
| 10 | GND | Ground for sensor supply (don't connect with system GND) |
| X6 Motor | | |
| 1 | Ma | Motor phase A |
| 2 | Mb | Motor phase B |
| 3 | Mc | Motor phase C |
| X7 Profinet - In port | | |
| X8 Profinet - Out port | | |

SVTE-A-E57-CanOpen Servo Drives

60VDC | 10A
DC motors, BLDC motors

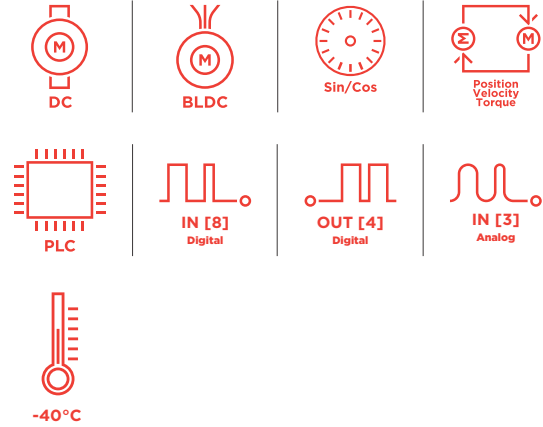
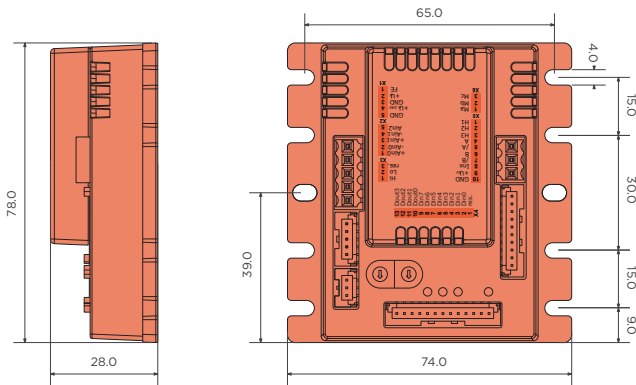

CANopen

| Values | Unit |
|--|--|
| Power | |
| 1 Electronic supply voltage Ue | VDC 9..30 |
| 2 Power supply voltage Up | VDC 9..60 |
| 3 Max. output current | A 50 |
| 4 Continuous output current @ Up=24VDC | A 10 |
| 5 Output voltage | Up to 100% |
| Motor types | |
| 6 DC motors | yes |
| 7 BLDC motors | yes |
| 8 Stepper motors | no |
| Mechanical | |
| 9 Size LxWxH | mm 78 x 74 x 28 |
| CAN bus | |
| 10 Protocol | DS301 |
| 11 Device profile | DS402 |
| 12 Galvanically isolated | no |
| Encoder | |
| 13 Input voltage | VDC 1 VDC peak-peak, differential |
| 14 Signal type | sin / cos, analog, differential, 1085 kOhm input impedance |
| 15 Resolution | 13 bit per sine period |
| Digital input | |
| 16 Number | 8 (Din0..7) |
| Digital output | |
| 17 Number | 4 (Dout0..3) |
| 18 Continuous output current | A 0.3 (Load: resistive, inductive) |
| Analog inputs | |
| 19 Number | 3 (Ain0..2) |
| 20 Signal type - Ain0..1 | +/- 10VDC, 12 Bit, differential, 200 kOhm input impedance |
| 21 Signal type - Ain2 | 0..5 VDC, 12 Bit, single ended, 5VDC pull up intern 1.5 kOhm |
| Environment | |
| 21 Operating temperature | °C -40...+70 |

Connection

| | | |
|----------------------------------|--------|--|
| X1 Supply | | |
| 1 | FE | Functional earth |
| 2 | +Up | Power supply voltage |
| 3 | GND | Ground for power supply voltage |
| 4 | +Ue24V | Electronic supply voltage |
| 5 | GND | Ground for electronic supply voltage |
| X2 Analog Inputs | | |
| 1 | +Ain0 | Analog input 0, positive |
| 2 | -Ain0 | Analog input 0, negative |
| 3 | +Ain1 | Analog input 1, positive |
| 4 | -Ain1 | Analog input 1, negative |
| 5 | Ain2 | Analog Input 2 (5V) |
| X3 CAN bus | | |
| 1 | CAN Hi | CAN High |
| 2 | CAN Lo | CAN Low |
| 3 | res. | Reserved |
| X4 Digital inputs/outputs | | |
| 1 | res. | Reserved |
| 2 | Din0 | Digital input 0 |
| 3 | Din1 | Digital input 1 |
| 4 | Din2 | Digital input 2 |
| 5 | Din3 | Digital input 3 |
| 6 | Din4 | Digital input 4 |
| 7 | Din5 | Digital input 5 |
| 8 | Din6 | Digital input 6 |
| 9 | Din7 | Digital input 7 |
| 10 | Dout0 | Digital output 0 |
| 11 | Dout1 | Digital output 1 |
| 12 | Dout2 | Digital output 2 |
| 13 | Dout3 | Digital output 3 |
| X5 Encoder SinCos | | |
| 1 | res. | Reserved |
| 2 | res. | Reserved |
| 3 | res. | Reserved |
| 4 | +Sin | Encoder, plus sine signal |
| 5 | -Sin | Encoder, minus sine signal |
| 6 | +Cos | Encoder, plus cosine signal |
| 7 | -Cos | Encoder, minus cosine signal |
| 8 | res. | Reserved |
| 9 | +U5V | 5V output voltage for sensor supply |
| 10 | GND | Ground for sensor supply (don't connect with system GND) |
| X6 Motor | | |
| 1 | Ma | Motor phase A |
| 2 | Mb | Motor phase B |
| 3 | Mc | Motor phase C |

SVTE-A-E50-HC-CanOpen Servo Drives

60VDC | 14.5A
DC motors, BLDC motors

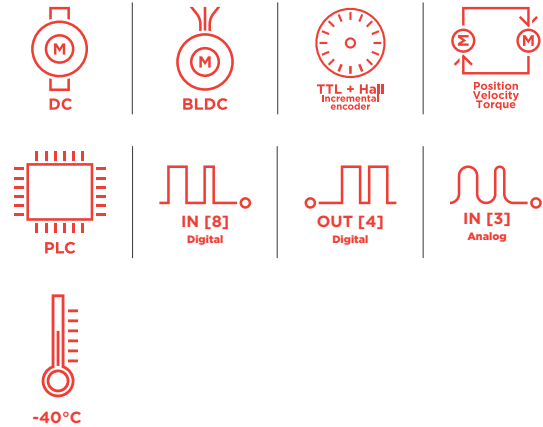
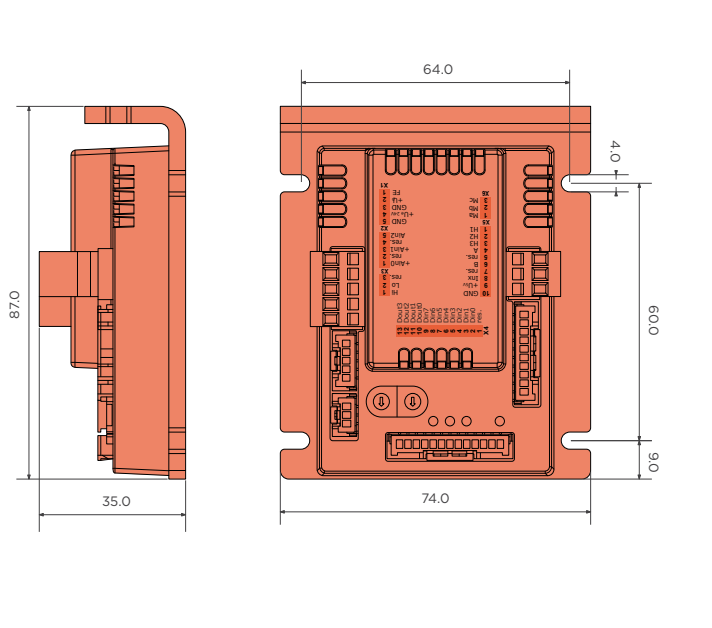

CANopen

| Values | Unit |
|---|------------------------------------|
| Power | |
| 1 Electronic supply voltage Ue | VDC 9..30 |
| 2 Power supply voltage Up | VDC 9..60 |
| 3 Max. output current | A 25 |
| 4 Continuous output current | A 14.5 |
| 5 Continuous output current @ Up=24VDC (certified UL) | A 9.5 |
| 6 Continuous output current @ Up=60VDC (certified UL) | A 9 |
| 7 Output voltage | Up to 90% |
| Motor types | |
| 8 DC motors | Yes |
| 9 BLDC motors | Yes |
| 10 Stepper motors | No |
| Mechanical | |
| 11 Size LxWxH | mm 87 x 74 x 28 |
| CAN bus | |
| 12 Protocol | DS301 |
| 13 Device profile | DS402 |
| 14 Galvanically isolated | no |
| Incremental encoder | |
| 15 Input voltage | VDC 0..5 |
| 16 Signal type | open collector, single ended |
| Hall sensors | |
| 17 Input voltage | VDC 0..5 |
| 18 Signal type | open collector, single ended |
| Digital input | |
| 19 Number | 8 (Din0..7) |
| Digital output | |
| 20 Number | 4 (Dout0..3) |
| 21 Continuous output current | A 0.3 (Load: resistive, inductive) |
| Analog inputs | |
| 22 Number | 3 (Ain0..2) |
| 23 Signal type - Ain0..1 | 0..10V, 12 Bit, Single Ended |
| 24 Signal type - Ain2 | 0..5V, 12 Bit, Single Ended |
| Environment | |
| 25 Operating temperature | °C -40..+70°C |

Connection

| | | |
|----------------------------------|--------|--|
| X1 Supply | | |
| 1 | FE | Functional earth |
| 2 | +Up | Power supply voltage |
| 3 | GND | Ground for power supply voltage |
| 4 | +Ue24V | Electronic supply voltage |
| 5 | GND | Ground for electronic supply voltage |
| X2 Analog Inputs | | |
| 1 | Ain0 | Analog input 0 |
| 2 | res. | Reserved |
| 3 | Ain1 | Analog input 1 |
| 4 | res. | Reserved |
| 5 | Ain2 | Analog Input 2 (5V) |
| X3 CAN bus | | |
| 1 | CAN Hi | CAN High |
| 2 | CAN Lo | CAN Low |
| 3 | res. | Reserved |
| X4 Digital inputs/outputs | | |
| 1 | res. | Reserved |
| 2 | Din0 | Digital input 0 |
| 3 | Din1 | Digital input 1 |
| 4 | Din2 | Digital input 2 |
| 5 | Din3 | Digital input 3 |
| 6 | Din4 | Digital input 4 |
| 7 | Din5 | Digital input 5 |
| 8 | Din6 | Digital input 6 |
| 9 | Din7 | Digital input 7 |
| 10 | Dout0 | Digital output 0 |
| 11 | Dout1 | Digital output 1 |
| 12 | Dout2 | Digital output 2 |
| 13 | Dout3 | Digital output 3 |
| X5 Hall and inc. encoder | | |
| 1 | H1 | Hall sensor 1 |
| 2 | H2 | Hall sensor 2 |
| 3 | H3 | Hall sensor 3 |
| 4 | A | Inc. encoder, A channel |
| 5 | res. | Reserved |
| 6 | B | Inc. encoder, B channel |
| 7 | res. | Reserved |
| 8 | Inx | Inc. encoder, index channel |
| 9 | +U5V | 5V output voltage for sensor supply |
| 10 | GND | Ground for sensor supply (don't connect with system GND) |
| X6 Motor | | |
| 1 | Ma | Motor phase A |
| 2 | Mb | Motor phase B |
| 3 | Mc | Motor phase C |

SVTE-A-E55-HC-CanOpen Servo Drives

60VDC | 14.5A
DC motors, BLDC motors

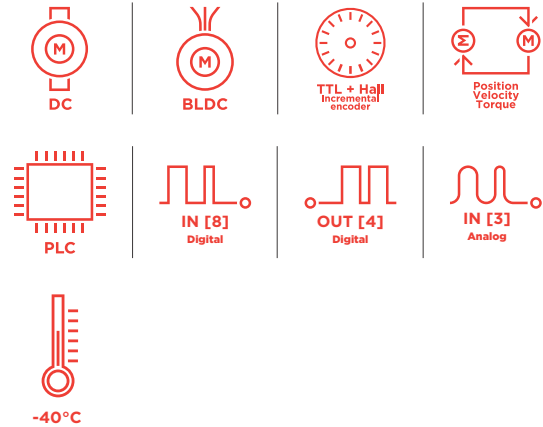
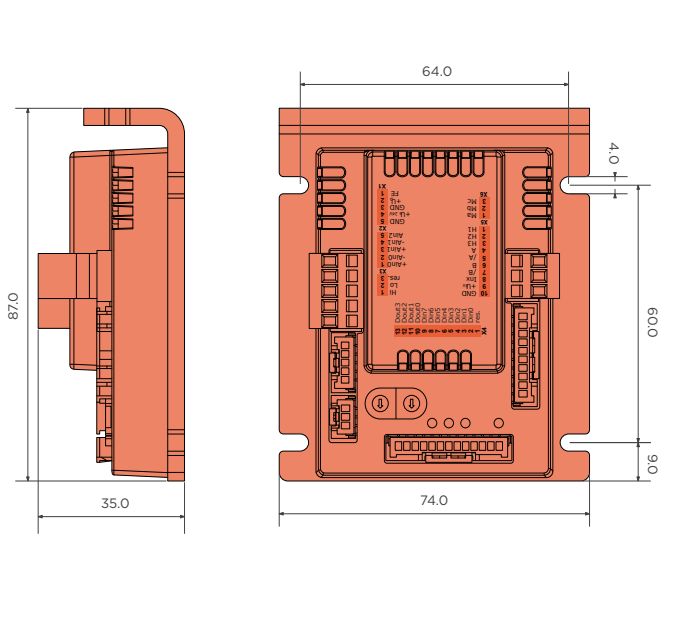

CANopen

| Values | Unit |
|---|------------------------------------|
| Power | |
| 1 Electronic supply voltage Ue | VDC 9..30 |
| 2 Power supply voltage Up | VDC 9..60 |
| 3 Max. output current | A 50 |
| 4 Continuous output current | A 14.5 |
| 5 Continuous output current @ Up=24VDC (certified UL) | A 9.5 |
| 6 Continuous output current @ Up=60VDC (certified UL) | A 9 |
| 7 Output voltage | Up to 100% |
| Motor types | |
| 8 DC motors | yes |
| 9 BLDC motors | yes |
| 10 Stepper motors | no |
| Mechanical | |
| 11 Size LxWxH | mm 87 x 74 x 28 |
| CAN bus | |
| 12 Protocol | DS301 |
| 13 Device profile | DS402 |
| 14 Galvanically isolated | no |
| Incremental encoder | |
| 15 Input voltage | VDC 0..5 |
| 16 Signal type | open collector, single ended |
| Hall sensors | |
| 17 Input voltage | VDC 0..5 |
| 18 Signal type | open collector, single ended |
| Digital input | |
| 19 Number | 8 (Din0..7) |
| Digital output | |
| 20 Number | 4 (Dout0..3) |
| 21 Continuous output current | A 0.3 (Load: resistive, inductive) |
| Analog inputs | |
| 22 Number | 3 (Ain0..2) |
| 23 Signal type - Ain0..1 | 0..10V, 12 Bit, Single Ended |
| 24 Signal type - Ain2 | 0..5V, 12 Bit, Single Ended |
| Environment | |
| 24 Operating temperature | °C -40..+70°C |

Connection

| | | |
|----------------------------------|--------|--|
| X1 Supply | | |
| 1 | FE | Functional earth |
| 2 | +Up | Power supply voltage |
| 3 | GND | Ground for power supply voltage |
| 4 | +Ue24V | Electronic supply voltage |
| 5 | GND | Ground for electronic supply voltage |
| X2 Analog Inputs | | |
| 1 | +Ain0 | Analog input 0, positive |
| 2 | -Ain0 | Analog input 0, negative |
| 3 | +Ain1 | Analog input 1, positive |
| 4 | -Ain1 | Analog input 1, negative |
| 5 | Ain2 | Analog Input 2 (5V) |
| X3 CAN bus | | |
| 1 | CAN Hi | CAN High |
| 2 | CAN Lo | CAN Low |
| 3 | res. | Reserved |
| X4 Digital inputs/outputs | | |
| 1 | res. | Reserved |
| 2 | Din0 | Digital input 0 |
| 3 | Din1 | Digital input 1 |
| 4 | Din2 | Digital input 2 |
| 5 | Din3 | Digital input 3 |
| 6 | Din4 | Digital input 4 |
| 7 | Din5 | Digital input 5 |
| 8 | Din6 | Digital input 6 |
| 9 | Din7 | Digital input 7 |
| 10 | Dout0 | Digital output 0 |
| 11 | Dout1 | Digital output 1 |
| 12 | Dout2 | Digital output 2 |
| 13 | Dout3 | Digital output 3 |
| X5 Hall and inc. encoder | | |
| 1 | H1 | Hall sensor 1 |
| 2 | H2 | Hall sensor 2 |
| 3 | H3 | Hall sensor 3 |
| 4 | A | Inc. encoder, A channel |
| 5 | /A | Inc. encoder, A channel invert |
| 6 | B | Inc. encoder, B channel |
| 7 | /B | Inc. encoder, B channel inverted |
| 8 | Inx | Inc. encoder, index channel |
| 9 | +U5V | 5V output voltage for sensor supply |
| 10 | GND | Ground for sensor supply (don't connect with system GND) |
| X6 Motor | | |
| 1 | Ma | Motor phase A |
| 2 | Mb | Motor phase B |
| 3 | Mc | Motor phase C |

SVTE-A-E55-HC-EtherCAT Servo Drives

60VDC | 14.5A
DC motors, BLDC motors

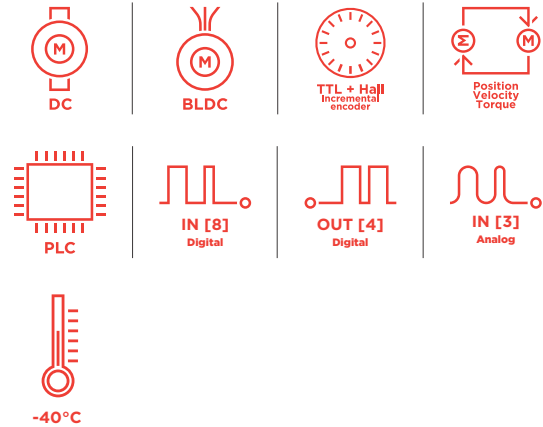
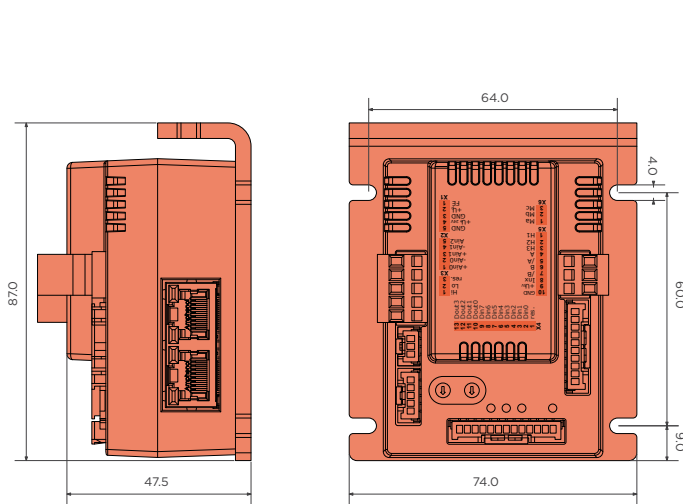

CANopen | EtherCAT

| Values | Unit |
|--------------------------------|--|
| Power | |
| 1 Electronic supply voltage Ue | VDC 9..30 |
| 2 Power supply voltage Up | VDC 9..60 |
| 3 Max. output current | A 50 |
| 4 Continuous output current | A 14.5 |
| 5 Output voltage | Up to 100% |
| Motor types | |
| 6 DC motors | yes |
| 7 BLDC motors | yes |
| 8 Stepper motors | no |
| Mechanical | |
| 9 Size LxWxH | mm 87 x 74 x 47 |
| CAN bus | |
| 10 Protocol | DS301 |
| 11 Device profile | DS402 |
| 12 Galvanically isolated | no |
| EtherCAT | |
| 13 Type | EtherCAT Slave |
| 14 Physical layer | 100 Base-Tx EtherCAT |
| 15 Max. baudrate | 100 Mbit/s |
| 16 Number of ports | 2xRJ45 (In,Out) |
| 17 Protocol | CoE (CANopen over EtherCAT) |
| Incremental encoder | |
| 18 Input voltage | VDC 0..5 |
| 19 Signal type | differential, open collector, single ended |
| Hall sensors | |
| 20 Input voltage | VDC 0..5 |
| 21 Signal type | open collector, single ended |
| Digital input | |
| 22 Number | 8 (Din0..7) |
| Digital output | |
| 23 Number | 4 (Dout0..3) |
| 24 Continuous output current | A 0.3 (Load: resistive, inductive) |
| Analog inputs | |
| 25 Number | 3 (Ain0..2) |
| 26 Signal type - Ain0..1 | +/-10V, 12 Bit, differential |
| 27 Signal type - Ain2 | 0..5V, 12 Bit, single ended |
| Environment | |
| 28 Operating temperature | °C -40..+70°C |

Connection

| | | |
|----------------------------------|--------|--|
| X1 Supply | | |
| 1 | FE | Functional earth |
| 2 | +Up | Power supply voltage |
| 3 | GND | Ground for power supply voltage |
| 4 | +Ue24V | Electronic supply voltage |
| 5 | GND | Ground for electronic supply voltage |
| X2 Analog Inputs | | |
| 1 | +Ain0 | Analog input 0, positive |
| 2 | -Ain0 | Analog input 0, negative |
| 3 | +Ain1 | Analog input 1, positive |
| 4 | -Ain1 | Analog input 1, negative |
| 5 | Ain2 | Analog Input 2 (5V) |
| X3 CAN bus | | |
| 1 | CAN Hi | CAN High |
| 2 | CAN Lo | CAN Low |
| 3 | res. | Reserved |
| X4 Digital inputs/outputs | | |
| 1 | res. | Reserved |
| 2 | Din0 | Digital input 0 |
| 3 | Din1 | Digital input 1 |
| 4 | Din2 | Digital input 2 |
| 5 | Din3 | Digital input 3 |
| 6 | Din4 | Digital input 4 |
| 7 | Din5 | Digital input 5 |
| 8 | Din6 | Digital input 6 |
| 9 | Din7 | Digital input 7 |
| 10 | Dout0 | Digital output 0 |
| 11 | Dout1 | Digital output 1 |
| 12 | Dout2 | Digital output 2 |
| 13 | Dout3 | Digital output 3 |
| X5 Hall and inc. encoder | | |
| 1 | H1 | Hall sensor 1 |
| 2 | H2 | Hall sensor 2 |
| 3 | H3 | Hall sensor 3 |
| 4 | A | Inc. encoder, A channel |
| 5 | /A | Inc. encoder, A channel invert |
| 6 | B | Inc. encoder, B channel |
| 7 | /B | Inc. encoder, B channel inverted |
| 8 | Inx | Inc. encoder, index channel |
| 9 | +U5V | 5V output voltage for sensor supply |
| 10 | GND | Ground for sensor supply (don't connect with system GND) |
| X6 Motor | | |
| 1 | Ma | Motor phase A |
| 2 | Mb | Motor phase B |
| 3 | Mc | Motor phase C |
| X7 EtherCAT - In port | | |
| X8 EtherCAT - Out port | | |

SVTE-A-E55-HC-Profinet Servo Drives

60VDC | 14.5A
DC motors, BLDC motors

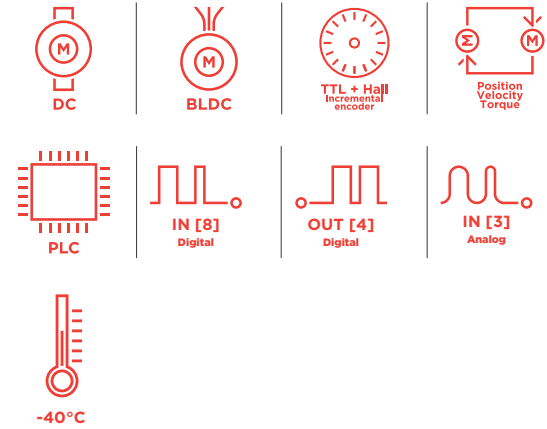
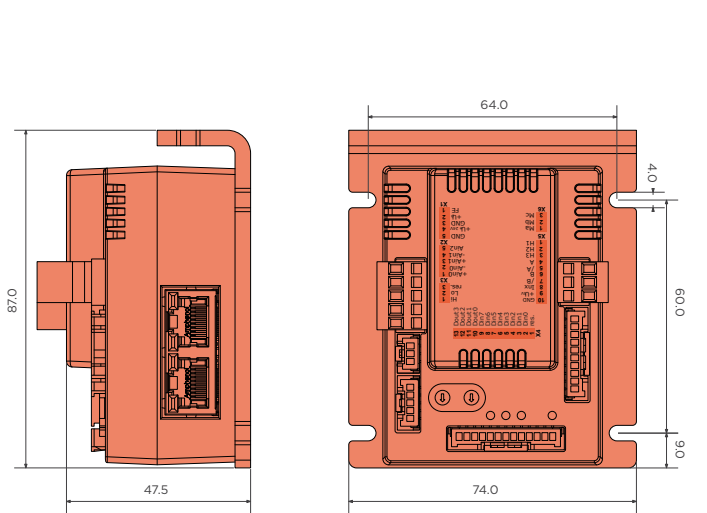

CANopen | PROFINET

| Values | Unit |
|-----------------------------------|--|
| Power | |
| 1 Electronic supply voltage Ue | VDC 9..30 |
| 2 Power supply voltage Up | Vdc 9..60 |
| 3 Max. output current | A 50 |
| 4 Continuous output current | A 14.5 |
| 5 Output voltage | Up to 100% |
| Motor types | |
| 6 DC motors | yes |
| 7 BLDC motors | yes |
| 8 Stepper motors | no |
| Mechanical | |
| 9 Size LxWxH | mm 78 x 74 x 47 |
| CAN bus | |
| 10 Protocol | DS301 |
| 11 Device profile | DS402 |
| 12 Galvanically isolated | no |
| Profinet | |
| 13 Type | Slave |
| 14 Physical layer | 100 Base-Tx |
| 15 Max. baudrate | 100 Mbit/s |
| 16 Number of ports | 2xRJ45 (PORT1,PORT2) |
| Incremental encoder | |
| 17 Input voltage (24VDC tolerant) | VDC 0..5 |
| 18 Signal type | differential, open collector, single ended |
| Hall sensors | |
| 19 Input voltage | VDC 0.5 |
| 20 Signal type | open collector, single ended |
| Digital input | |
| 21 Number | 8 (Din0..7) |
| Digital output | |
| 22 Number | 4 (Dout0..3) |
| 23 Continuous output current | A 0.3 |
| Analog inputs | |
| 24 Number | 3 (Ain0..2) |
| 25 Signal type - Ain0...1 | +/- 10 V, 12 Bit, differential |
| 26 Signal type - Ain2 | 0..5 V, 12 Bit, single ended |
| Environment | |
| 27 Operating temperature | °C -40..+70°C |

Connection

| | | |
|----------------------------------|--------|--|
| X1 Supply | | |
| 1 | FE | Functional earth |
| 2 | +Up | Power supply voltage |
| 3 | GND | Ground for power supply voltage |
| 4 | +Ue24V | Electronic supply voltage |
| 5 | GND | Ground for electronic supply voltage |
| X2 Analog Inputs | | |
| 1 | +Ain0 | Analog input 0, positive |
| 2 | -Ain0 | Analog input 0, negative |
| 3 | +Ain1 | Analog input 1, positive |
| 4 | -Ain1 | Analog input 1, negative |
| 5 | Ain2 | Analog Input 2 (5V) |
| X3 CAN bus | | |
| 1 | CAN Hi | CAN High |
| 2 | CAN Lo | CAN Low |
| 3 | res. | Reserved |
| X4 Digital inputs/outputs | | |
| 1 | res. | Reserved |
| 2 | Din0 | Digital input 0 |
| 3 | Din1 | Digital input 1 |
| 4 | Din2 | Digital input 2 |
| 5 | Din3 | Digital input 3 |
| 6 | Din4 | Digital input 4 |
| 7 | Din5 | Digital input 5 |
| 8 | Din6 | Digital input 6 |
| 9 | Din7 | Digital input 7 |
| 10 | Dout0 | Digital output 0 |
| 11 | Dout1 | Digital output 1 |
| 12 | Dout2 | Digital output 2 |
| 13 | Dout3 | Digital output 3 |
| X5 Hall and inc. encoder | | |
| 1 | H1 | Hall sensor 1 |
| 2 | H2 | Hall sensor 2 |
| 3 | H3 | Hall sensor 3 |
| 4 | A | Inc. encoder, A channel |
| 5 | /A | Inc. encoder, A channel invert |
| 6 | B | Inc. encoder, B channel |
| 7 | /B | Inc. encoder, B channel inverted |
| 8 | Inx | Inc. encoder, index channel |
| 9 | +U5V | 5V output voltage for sensor supply |
| 10 | GND | Ground for sensor supply (don't connect with system GND) |
| X6 Motor | | |
| 1 | Ma | Motor phase A |
| 2 | Mb | Motor phase B |
| 3 | Mc | Motor phase C |
| X7 Profinet - In port | | |
| X8 Profinet - Out port | | |

SVTE-A-E60-CanOpen Servo Drives

60VDC | 5A
DC motors, BLDC motors

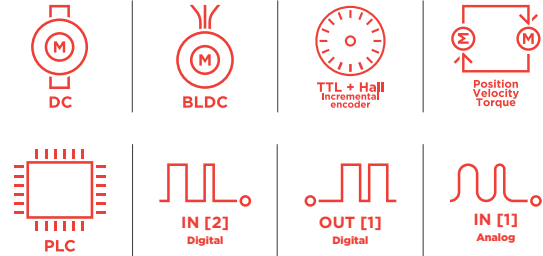
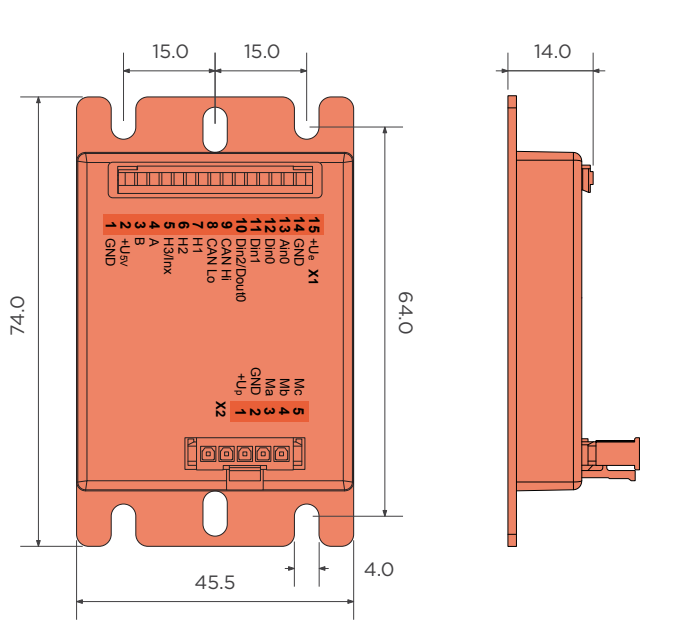

CANopen

| Values | Unit |
|--|--|
| Power | |
| 1 Electronic supply voltage Ue | VDC 9..30 |
| 2 Power supply voltage Up | VDC 9..60 |
| 3 Max. output current | A 15 |
| 4 Continuous output current @ Up=24VDC | A 5 |
| 5 Continuous output current @ Up=48VDC | A 4.3 |
| 6 Output voltage | Up to 90% |
| Motor types | |
| 7 DC motors | yes |
| 8 BLDC motors | yes |
| 9 Stepper motors | no |
| Mechanical | |
| 10 Size LxWxH | mm 74 x 45.5 x 14 |
| CAN bus | |
| 11 Protocol | DS301 |
| 12 Device profile | DS402 |
| 13 Galvanically isolated | no |
| Incremental encoder | |
| 14 Input voltage | VDC 0..5 |
| 15 Signal type | open collector, single ended |
| Hall sensor | |
| 16 Input voltage | VDC 0..5 |
| 17 Signal type | open collector, single ended |
| Digital input | |
| 18 Number (+/-30VDC tolerant) | 2 (Din0..1) |
| 19 Number (0..30VDC tolerant) | 1 (Din2); Din2 parallel with Dout0 (must not exceed electronic supply voltage) |
| Digital output | |
| 20 Number | 1 (Dout0); Dout0 parallel with Din2 |
| 21 Continuous output current | A 1.5 (Load: resistive, inductive) |
| Analog inputs | |
| 22 Number | 1 (Ain0) |
| 23 Signal type | 0..10 VDC, 12 Bit, single ended |
| Environment | |
| 24 Operating temperature | °C -25...+70 |

Connection

X1 Hall, inc. encoder, I/O's and CAN

| | | |
|----|------------|---|
| 1 | GND | Ground of the auxiliary voltage (don't connect with system GND) |
| 2 | +U5V | 5V output voltage for sensor supply Sensors: encoder, hall |
| 3 | B | Inc. encoder, B channel |
| 4 | A | Inc. encoder, A channel |
| 5 | H3/Inx | Hall sensor 3 / Inc. encoder, index channel |
| 6 | H2 | Hall sensor 2 |
| 7 | H1 | Hall sensor 1 |
| 8 | CAN Lo | CAN Low |
| 9 | CAN Hi | CAN High |
| 10 | Din2/Dout0 | Digital input 2 / Digital output 0 |
| 11 | Din1 | Digital input 1 |
| 12 | Din0 | Digital input 0 |
| 13 | Ain0 | Analog input 0 |
| 14 | GND | Ground for electronic supply voltage |
| 15 | +Ue | Electronic supply voltage |

X2 Motor

| | | |
|---|-----|--------------------------|
| 1 | +Up | Power supply voltage |
| 2 | GND | Ground for sensor supply |
| 3 | Ma | Motor phase A |
| 4 | Mb | Motor phase B |
| 5 | Mc | Motor phase C |

SVTE-A-E60-EtherCAT Servo Drives

60VDC | 5A
DC motors, BLDC motors

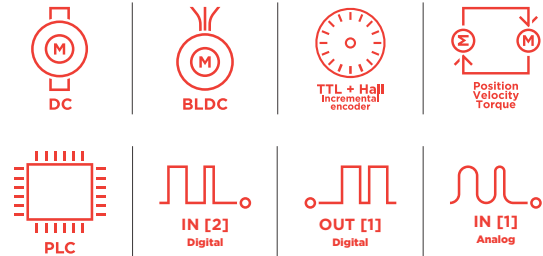
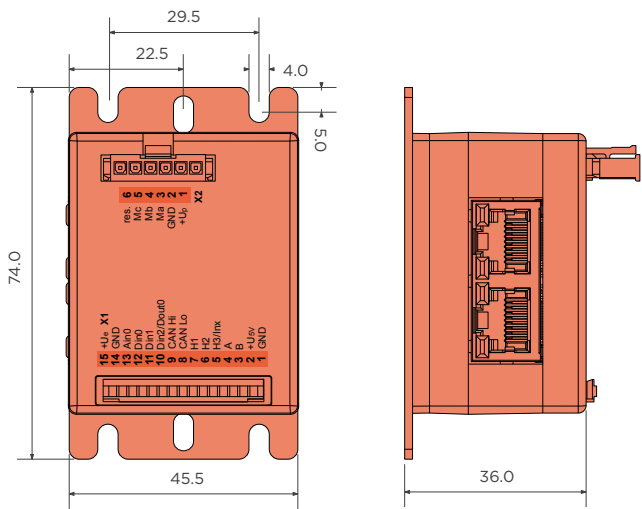

CANopen | EtherCAT

| Values | Unit |
|--|--|
| Power | |
| 1 Electronic supply voltage Ue | VDC 9..30 |
| 2 Power supply voltage Up | VDC 9..60 |
| 3 Max. output current | A 15 |
| 4 Continuous output current @ Up=24VDC | A 5 |
| 5 Continuous output current @ Up=48VDC | A 4.3 |
| 6 Output voltage | Up to 90% |
| Motor types | |
| 7 DC motors | yes |
| 8 BLDC motors | yes |
| 9 Stepper motors | no |
| Mechanical | |
| 10 Size LxWxH | mm 74 x 45.5 x 36 |
| CAN bus | |
| 11 Protocol | DS301 |
| 12 Device profile | DS402 |
| 13 Galvanically isolated | no |
| EtherCAT | |
| 14 Type | EtherCAT Slave |
| 15 Physical layer | 100 Base-Tx EtherCAT |
| 16 Max. baudrate | 100 Mbit/s |
| 17 Number of ports | 2xRJ45 (In,Out) |
| 18 Protocol | CoE (CANopen over EtherCAT) |
| Incremental encoder | |
| 19 Input voltage | VDC 0..5 |
| 20 Signal type | open collector, single ended |
| Hall sensors | |
| 21 Input voltage | VDC 0..5 |
| 22 Signal type | open collector, single ended |
| Digital input | |
| 23 Number (+/-30VDC tolerant) | 2 (Din0..1) |
| 24 Number (0..30VDC tolerant) | 1 (Din2); Din2 parallel with Dout0 (must not exceed electronic supply voltage) |
| Digital output | |
| 25 Number | 1 (Dout0); Dout0 parallel with Din2 |
| 26 Continuous output current | A 1.5 (Load: resistive, inductive) |
| Analog inputs | |
| 27 Number | 1 (Ain0) |
| 28 Signal type | 0..10 VDC, 12 Bit, single ended |
| Environment | |
| 29 Operating temperature | °C -25...+70 |

Connection

X1 Hall, inc. encoder, I/O's and CAN

| | | |
|----|------------|---|
| 1 | GND | Ground of the auxiliary voltage (don't connect with system GND) |
| 2 | +U5V | 5V output voltage for sensor supply Sensors: encoder, hall |
| 3 | B | Inc. encoder, B channel |
| 4 | A | Inc. encoder, A channel |
| 5 | H3/Inx | Hall sensor 3 / Inc. encoder, index channel |
| 6 | H2 | Hall sensor 2 |
| 7 | H1 | Hall sensor 1 |
| 8 | CAN Lo | CAN Low |
| 9 | CAN Hi | CAN High |
| 10 | Din2/Dout0 | Digital input 2 / Digital output 0 |
| 11 | Din1 | Digital input 1 |
| 12 | Din0 | Digital input 0 |
| 13 | Ain0 | Analog input 0 |
| 14 | GND | Ground for electronic supply voltage |
| 15 | +Ue | Electronic supply voltage |

X2 Motor

| | | |
|---|------|--------------------------|
| 1 | +Up | Power supply voltage |
| 2 | GND | Ground for sensor supply |
| 3 | Ma | Motor phase A |
| 4 | Mb | Motor phase B |
| 5 | Mc | Motor phase C |
| 6 | res. | Reserved |

X3 EtherCAT - In port**X4 EtherCAT - Out port**

SVTE-A-E65-CanOpen Servo Drives

60VDC | 5A
DC motors, BLDC motors

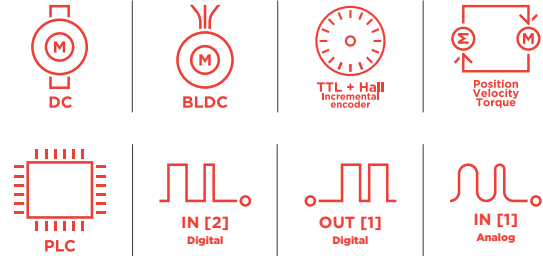
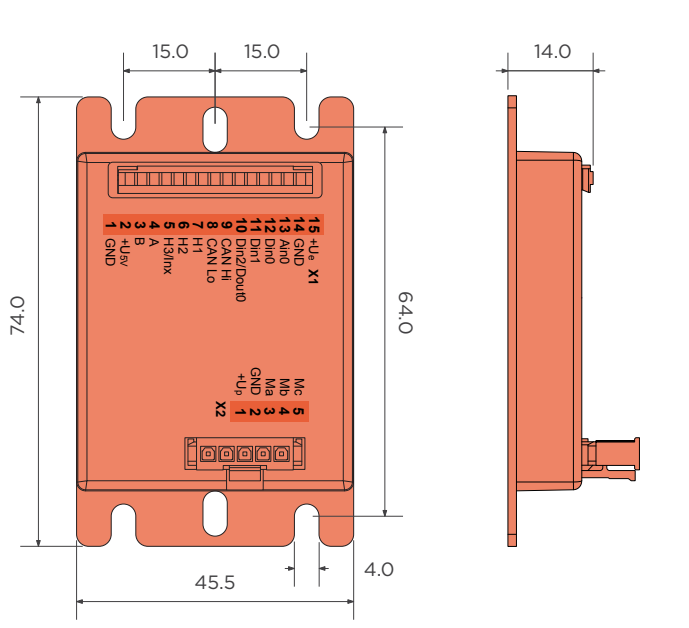

CANopen

| Values | Unit |
|--|--|
| Power | |
| 1 Electronic supply voltage Ue | VDC 9..30 |
| 2 Power supply voltage Up | VDC 9..60 |
| 3 Max. output current | A 15 |
| 4 Continuous output current @ Up=24VDC | A 5 |
| 5 Continuous output current @ Up=48VDC | A 4.3 |
| 6 Output voltage | Up to 100% |
| Motor types | |
| 7 DC motors | yes |
| 8 BLDC motors | yes |
| 9 Stepper motors | no |
| Mechanical | |
| 10 Size LxWxH | mm 74 x 45.5 x 14 |
| CAN bus | |
| 11 Protocol | DS301 |
| 12 Device profile | DS402 |
| 13 Galvanically isolated | no |
| Incremental encoder | |
| 14 Input voltage | VDC 0..5 |
| 15 Signal type | open collector, single ended |
| Hall sensors | |
| 16 Input voltage | VDC 0..5 |
| 17 Signal type | open collector, single ended |
| Digital input | |
| 18 Number | 2 (Din0..1) |
| 19 Number (0..30VDC tolerant) | 1 (Din2); Din2 parallel with Dout0 (must not exceed electronic supply voltage) |
| Digital output | |
| 20 Number | 1 (Dout0); Dout0 parallel with Din2 |
| 21 Continuous output current | A 1.5 (Load: resistive, inductive) |
| Analog inputs | |
| 22 Number | 1 (Ain0) |
| 23 Signal type | +/- 10 VDC, 12 Bit, single ended |
| Environment | |
| 24 Operating temperature | °C -25...+70 |

Connection

| X1 Hall, inc. encoder, I/O's and CAN | | |
|--------------------------------------|------------|---|
| 1 | GND | Ground of the auxiliary voltage (don't connect with system GND) |
| 2 | +U5V | 5V output voltage for sensor supply Sensors: encoder, hall |
| 3 | B | Inc. encoder, B channel |
| 4 | A | Inc. encoder, A channel |
| 5 | H3/Inx | Hall sensor 3 / Inc. encoder, index channel |
| 6 | H2 | Hall sensor 2 |
| 7 | H1 | Hall sensor 1 |
| 8 | CAN Lo | CAN Low |
| 9 | CAN Hi | CAN High |
| 10 | Din2/Dout0 | Digital input 2 / Digital output 0 |
| 11 | Din1 | Digital input 1 |
| 12 | Din0 | Digital input 0 |
| 13 | Ain0 | Analog input 0 |
| 14 | GND | Ground for electronic supply voltage |
| 15 | +Ue | Electronic supply voltage |
| X2 Motor | | |
| 1 | +Up | Power supply voltage |
| 2 | GND | Ground for sensor supply |
| 3 | Ma | Motor phase A |
| 4 | Mb | Motor phase B |
| 5 | Mc | Motor phase C |

SVTE-A-E65-EtherCAT Servo Drives

60VDC | 5A
DC motors, BLDC motors

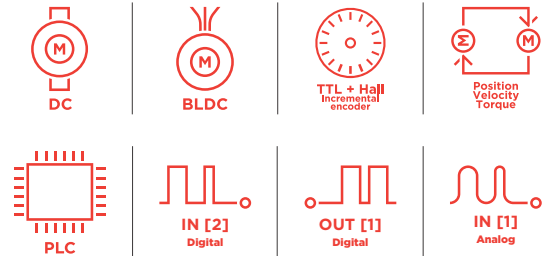
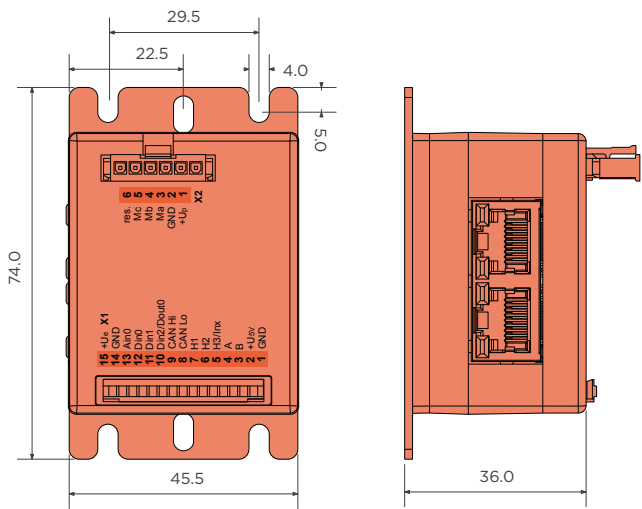

CANopen | EtherCAT

| Values | Unit |
|--|--|
| Power | |
| 1 Electronic supply voltage Ue | VDC 9..30 |
| 2 Power supply voltage Up | VDC 9..60 |
| 3 Max. output current | A 15 |
| 4 Continuous output current @ Up=24VDC | A 5 |
| 5 Continuous output current @ Up=48VDC | A 4.3 |
| 6 Output voltage | Up to 100% |
| Motor types | |
| 7 DC motors | yes |
| 8 BLDC motors | yes |
| 9 Stepper motors | no |
| Mechanical | |
| 10 Size LxWxH | mm 74 x 45.5 x 36 |
| CAN bus | |
| 11 Protocol | DS301 |
| 12 Device profile | DS402 |
| 13 Galvanically isolated | no |
| EtherCAT | |
| 14 Type | EtherCAT Slave |
| 15 Physical layer | 100 Base-Tx EtherCAT |
| 16 Max. baudrate | 100 Mbit/s |
| 17 Number of ports | 2xRJ45 (In,Out) |
| 18 Protocol | CoE (CANopen over EtherCAT) |
| Incremental encoder | |
| 19 Input voltage | VDC 0..5 |
| 20 Signal type | open collector, single ended |
| Hall sensors | |
| 21 Input voltage | VDC 0..5 |
| 22 Signal type | open collector, single ended |
| Digital input | |
| 23 Number | 2 (Din0..1) |
| 24 Number (0..30VDC tolerant) | 1 (Din2); Din2 parallel with Dout0 (must not exceed electronic supply voltage) |
| Digital output | |
| 25 Number | 1 (Dout0); Dout0 parallel with Din2 |
| 26 Continuous output current | A 1.5 (Load: resistive, inductive) |
| Analog inputs | |
| 27 Number | 1 (Ain0) |
| 28 Signal type | +/- 0..10 VDC, 12 Bit, single ended |
| Environment | |
| 29 Operating temperature | °C -25...+70 |

Connection

X1 Hall, inc. encoder, I/O's and CAN

| | | |
|----|------------|---|
| 1 | GND | Ground of the auxiliary voltage (don't connect with system GND) |
| 2 | +U5V | 5V output voltage for sensor supply Sensors: encoder, hall |
| 3 | B | Inc. encoder, B channel |
| 4 | A | Inc. encoder, A channel |
| 5 | H3/Inx | Hall sensor 3 / Inc. encoder, index channel |
| 6 | H2 | Hall sensor 2 |
| 7 | H1 | Hall sensor 1 |
| 8 | CAN Lo | CAN Low |
| 9 | CAN Hi | CAN High |
| 10 | Din2/Dout0 | Digital input 2 / Digital output 0 |
| 11 | Din1 | Digital input 1 |
| 12 | Din0 | Digital input 0 |
| 13 | Ain0 | Analog input 0 |
| 14 | GND | Ground for electronic supply voltage |
| 15 | +Ue | Electronic supply voltage |

X2 Motor

| | | |
|---|------|--------------------------|
| 1 | +Up | Power supply voltage |
| 2 | GND | Ground for sensor supply |
| 3 | Ma | Motor phase A |
| 4 | Mb | Motor phase B |
| 5 | Mc | Motor phase C |
| 6 | res. | Reserved |

X3 EtherCAT - In port**X4 EtherCAT - Out port**

SVTE-A-E65-Profinet Servo Drives

60VDC | 5A
DC motors, BLDC motors

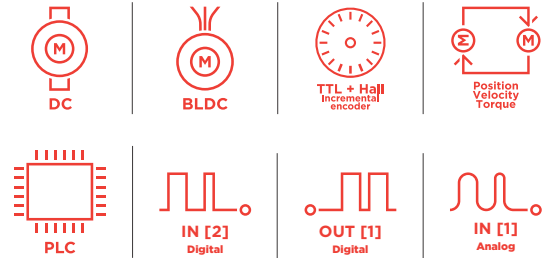
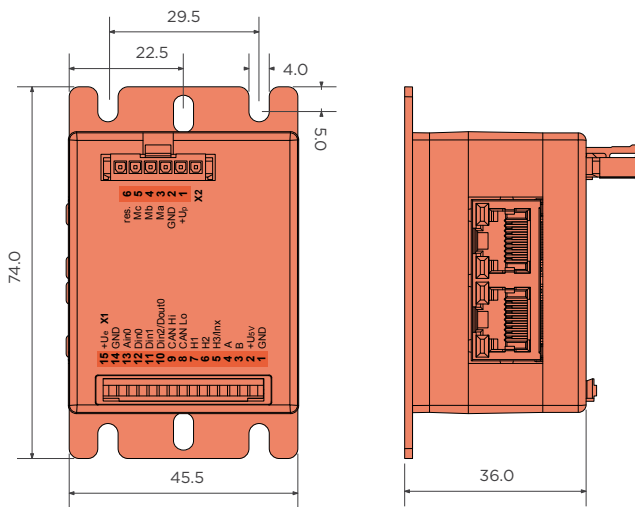

CANopen | PROFIBUS NET

| Values | Unit |
|--|--|
| Power | |
| 1 Electronic supply voltage Ue | VDC 9..30 |
| 2 Power supply voltage Up | VDC 9..60 |
| 3 Max. output current | A 15 |
| 4 Continuous output current @ Up=24VDC | A 5 |
| 5 Continuous output current @ Up=48VDC | A 4.3 |
| 6 Output voltage | Up to 100% |
| Motor types | |
| 7 DC motors | yes |
| 8 BLDC motors | yes |
| 9 Stepper motors | no |
| Mechanical | |
| 10 Size LxWxH | mm 74 x 45.5 x 36 |
| CAN bus | |
| 11 Protocol | DS301 |
| 12 Device profile | DS402 |
| 13 Galvanically isolated | no |
| Profinet | |
| 14 Type | Slave |
| 15 Physical layer | 100 Base-Tx |
| 16 Max. baudrate | 100 Mbit/s |
| 17 Number of ports | 2xRJ45 (PORT1, PORT2) |
| Incremental encoder | |
| 18 Input voltage | VDC 0..5 |
| 19 Signal type | open collector, single ended |
| Hall sensors | |
| 20 Input voltage | VDC 0..5 |
| 21 Signal type | open collector, single ended |
| Digital input | |
| 22 Number | 2 (Din0..1) |
| 23 Number (0..30Vdc tolerant) | 1 (Din2); Din2 parallel with Dout0 (must not exceed electronic supply voltage) |
| Digital output | |
| 24 Number | 1 (Dout0); Dout0 parallel with Din2 |
| 25 Continuous output current | A 1.5 (Load: resistive, inductive) |
| Analog inputs | |
| 26 Number | 1 (Ain0) |
| 27 Signal type | +/- 10 Vdc, 12 Bit, single ended |
| Environment | |
| 28 Operating temperature | °C -25...+70 |

Connection

| X1 Hall, inc. encoder, I/O's and CAN | | |
|--------------------------------------|------------|---|
| 1 | GND | Ground of the auxiliary voltage (don't connect with system GND) |
| 2 | +U5V | 5V output voltage for sensor supply Sensors: encoder, hall |
| 3 | B | Inc. encoder, B channel |
| 4 | A | Inc. encoder, A channel |
| 5 | H3/Inx | Hall sensor 3 / Inc. encoder, index channel |
| 6 | H2 | Hall sensor 2 |
| 7 | H1 | Hall sensor 1 |
| 8 | CAN Lo | CAN Low |
| 9 | CAN Hi | CAN High |
| 10 | Din2/Dout0 | Digital input 2 / Digital output 0 |
| 11 | Din1 | Digital input 1 |
| 12 | Din0 | Digital input 0 |
| 13 | Ain0 | Analog input 0 |
| 14 | res. | Reserved |
| 15 | +Ue | Electronic supply voltage |
| X2 Motor | | |
| 1 | +Up | Power supply voltage |
| 2 | GND | Ground for sensor supply |
| 3 | Ma | Motor phase A |
| 4 | Mb | Motor phase B |
| 5 | Mc | Motor phase C |
| 6 | res. | Reserved |
| X3 Profinet - PORT1 | | |
| X4 Profinet - PORT2 | | |

SVTE-A-E67-CanOpen Servo Drives

60VDC | 5A
DC motors, BLDC motors

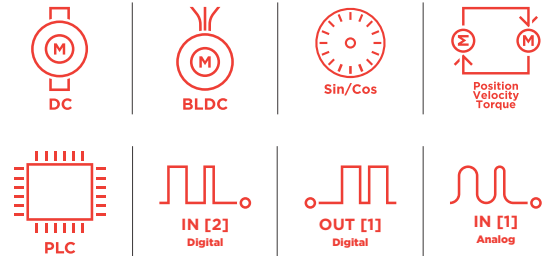
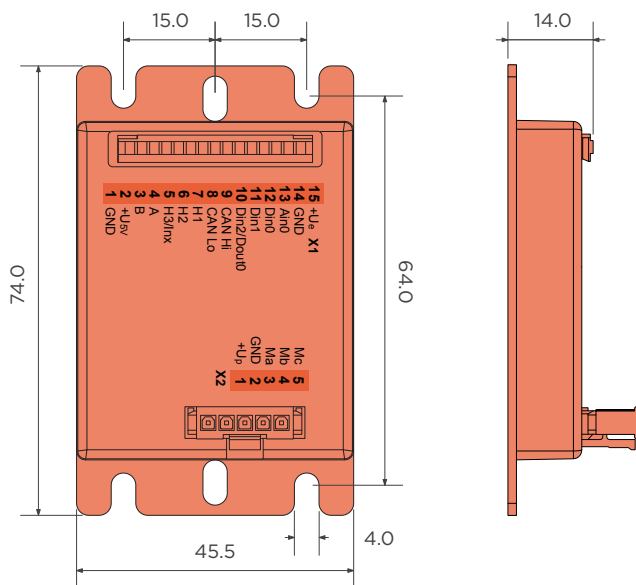

CANopen

| Values | Unit |
|---|--|
| Power | |
| 1 Electronic supply voltage U _e | VDC 9..30 |
| 2 Power supply voltage U _p | VDC 9..60 |
| 3 Max. output current | A 15 |
| 4 Continuous output current @ U _p =24VDC | A 5 |
| 5 Continuous output current @ U _p =48VDC | A 4.3 |
| 6 Output voltage | Up to 100% |
| Motor types | |
| 7 DC motors | yes |
| 8 BLDC motors | yes |
| 9 Stepper motors | no |
| Mechanical | |
| 10 Size LxWxH | mm 74 x 45.5 x 14 |
| CAN bus | |
| 11 Protocol | DS301 |
| 12 Device profile | DS402 |
| 13 Galvanically isolated | no |
| Encoder | |
| 14 Input voltage (24VDC tolerant) | 1 V peak-peak, differential |
| 15 Signal type | sin / cos, analog, differential |
| 16 Resolution | 13 bit per sine period |
| Digital input | |
| 17 Number | 2 (Din0..1) |
| 18 Number (0..30Vdc tolerant) | 1 (Din2); Din2 parallel with Dout0 (must not exceed electronic supply voltage) |
| Digital output | |
| 19 Number | 1 (Dout0); Dout0 parallel with Din2 |
| 20 Continuous output current | A 1.5 (Load: resistive, inductive) |
| Analog inputs | |
| 21 Number | 1 (Ain0) |
| 22 Signal type | +/- 10 VDC, 12 Bit, single ended |
| Environment | |
| 23 Operating temperature | °C -25...+70 |

Connection

X1 Encoder, I/O's and CAN

| | | |
|----|------------|---|
| 1 | GND | Ground of the auxiliary voltage (don't connect with system GND) |
| 2 | +U5V | 5V output voltage for sensor supply Sensors |
| 3 | +Cos | Cosine + signal |
| 4 | +Sin | Sine + signal |
| 5 | res. | Reserved |
| 6 | -Cos | Cosine - signal |
| 7 | -Sin | Sine - signal |
| 8 | CAN Lo | CAN Low |
| 9 | CAN Hi | CAN High |
| 10 | Din2/Dout0 | Digital input 2 / Digital output 0 |
| 11 | Din1 | Digital input 1 |
| 12 | Din0 | Digital input 0 |
| 13 | Ain0 | Analog input 0 |
| 14 | GND | Ground for electronic supply voltage |
| 15 | +Ue | Electronic supply voltage |

X2 Motor

| | | |
|---|-----|--------------------------|
| 1 | +Up | Power supply voltage |
| 2 | GND | Ground for sensor supply |
| 3 | Ma | Motor phase A |
| 4 | Mb | Motor phase B |
| 5 | Mc | Motor phase C |

SVTE-A-E67-EtherCAT Servo Drives

60VDC | 5A
DC motors, BLDC motors

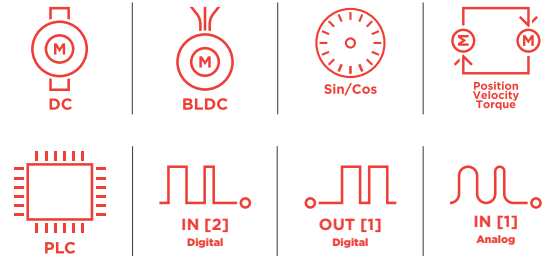
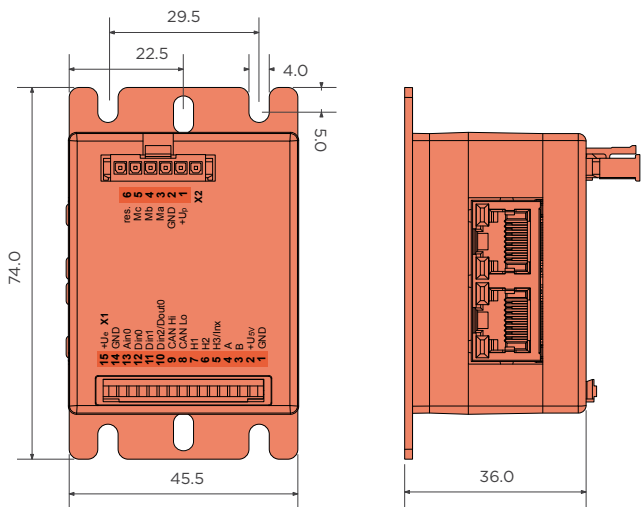

CANopen | EtherCAT

| Values | Unit |
|--|--|
| Power | |
| 1 Electronic supply voltage Ue | VDC 9..30 |
| 2 Power supply voltage Up | VDC 9..60 |
| 3 Max. output current | A 15 |
| 4 Continuous output current @ Up=24VDC | A 5 |
| 5 Continuous output current @ Up=48VDC | A 4.3 |
| 6 Output voltage | Up to 100% |
| Motor types | |
| 7 DC motors | yes |
| 8 BLDC motors | yes |
| 9 Stepper motors | no |
| Mechanical | |
| 10 Size LxWxH | mm 74 x 45.5 x 36 |
| CAN bus | |
| 11 Protocol | DS301 |
| 12 Device profile | DS402 |
| 13 Galvanically isolated | no |
| EtherCAT | |
| 14 Type | EtherCAT Slave |
| 15 Physical layer | 100 Base-Tx EtherCAT |
| 16 Max. baudrate | 100 Mbit/s |
| 17 Number of ports | 2xRJ45 (In,Out) |
| 18 Protocol | CoE (CANopen over EtherCAT) |
| Encoder | |
| 19 Input voltage (24VDC tolerant) | 1 V peak-peak, differential |
| 20 Signal type | sin/cos, analog, differential |
| 21 Resolution | 13 bit per sine period |
| Digital input | |
| 22 Number | 2 (Din0..1) |
| 23 Number (0..30VDC tolerant) | 1 (Din2); Din2 parallel with Dout0 (must not exceed electronic supply voltage) |
| Digital output | |
| 24 Number | 1 (Dout0); Dout0 parallel with Din2 |
| 25 Continuous output current | A 1.5 (Load: resistive, inductive) |
| Analog inputs | |
| 26 Number | 1 (Ain0) |
| 27 Signal type | +/- 10 VDC, 12 Bit, single ended |
| Environment | |
| 27 Operating temperature | °C -25...+70 |

Connection

X1 Encoder, I/O's and CAN

| | | |
|----|------------|---|
| 1 | GND | Ground of the auxiliary voltage (don't connect with system GND) |
| 2 | +U5V | 5V output voltage for sensor supply Sensors |
| 3 | +Cos | Cosine + signal |
| 4 | +Sin | Sine + signal |
| 5 | res. | Reserved |
| 6 | -Cos | Cosine - signal |
| 7 | -Sin | Sine - signal |
| 8 | CAN Lo | CAN Low |
| 9 | CAN Hi | CAN High |
| 10 | Din2/Dout0 | Digital input 2 / Digital output 0 |
| 11 | Din1 | Digital input 1 |
| 12 | Din0 | Digital input 0 |
| 13 | Ain0 | Analog input 0 |
| 14 | GND | Ground for electronic supply voltage |
| 15 | +Ue | Electronic supply voltage |

X2 Motor

| | | |
|---|------|--------------------------|
| 1 | +Up | Power supply voltage |
| 2 | GND | Ground for sensor supply |
| 3 | Ma | Motor phase A |
| 4 | Mb | Motor phase B |
| 5 | Mc | Motor phase C |
| 6 | res. | Reserved |

X3 EtherCAT - In port**X4 EtherCAT - Out port**

SVTE-A-E67-Profinet Servo Drives

60VDC | 5A
DC motors, BLDC motors

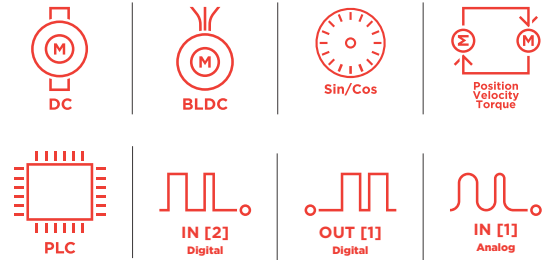
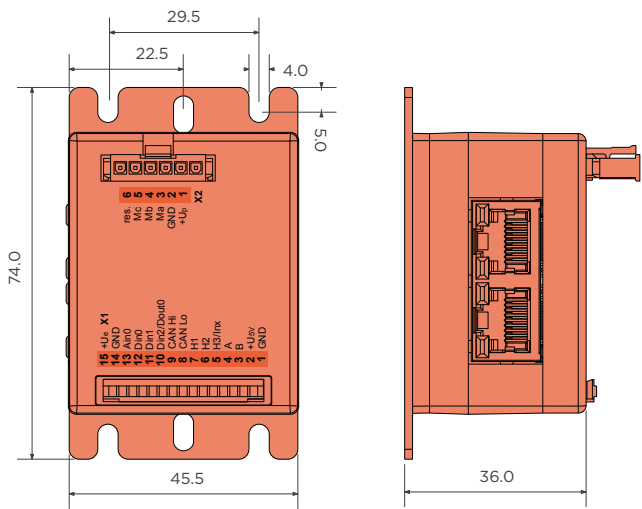

CANopen | PROFINET

| Values | Unit |
|--|--|
| Power | |
| 1 Electronic supply voltage Ue | VDC 9..30 |
| 2 Power supply voltage Up | VDC 9..60 |
| 3 Max. output current | A 15 |
| 4 Continuous output current @ Up=24VDC | A 5 |
| 5 Continuous output current @ Up=48VDC | A 4.3 |
| 6 Output voltage | Up to 100% |
| Motor types | |
| 7 DC motors | yes |
| 8 BLDC motors | yes |
| 9 Stepper motors | no |
| Mechanical | |
| 10 Size LxWxH | mm 74 x 45.5 x 36 |
| CAN bus | |
| 11 Protocol | DS301 |
| 12 Device profile | DS402 |
| 13 Galvanically isolated | no |
| Profinet | |
| 14 Type | Slave |
| 15 Physical layer | 100 Base-Tx |
| 16 Max. baudrate | 100 Mbit/s |
| 17 Number of ports | 2xRJ45 (PORT1, PORT2) |
| Encoder | |
| 18 Input voltage (24VDC tolerant) | 1 V peak-peak, differential |
| 19 Signal type | sin/cos, analog, differential |
| 20 Resolution | 13 bit per sine period |
| Digital input | |
| 21 Number | 2 (Din0..1) |
| 22 Number (0..30VDC tolerant) | 1 (Din2); Din2 parallel with Dout0 (must not exceed electronic supply voltage) |
| Digital output | |
| 23 Number | 1 (Dout0); Dout0 parallel with Din2 |
| 24 Continuous output current | A 1.5 (Load: resistive, inductive) |
| Analog inputs | |
| 25 Number | 1 (Ain0) |
| 26 Signal type | +/- 10 VDC, 12 Bit, single ended |
| Environment | |
| 26 Operating temperature | °C -25...+70 |

Connection

X1 Encoder, I/O's and CAN

| | | |
|----|------------|---|
| 1 | GND | Ground of the auxiliary voltage (don't connect with system GND) |
| 2 | +U5V | 5V output voltage for sensor supply Sensors |
| 3 | +Cos | Cosine + signal |
| 4 | +Sin | Sine + signal |
| 5 | res. | Reserved |
| 6 | -Cos | Cosine - signal |
| 7 | -Sin | Sine - signal |
| 8 | CAN Lo | CAN Low |
| 9 | CAN Hi | CAN High |
| 10 | Din2/Dout0 | Digital input 2 / Digital output 0 |
| 11 | Din1 | Digital input 1 |
| 12 | Din0 | Digital input 0 |
| 13 | Ain0 | Analog input 0 |
| 14 | GND | Ground for electronic supply voltage |
| 15 | +Ue | Electronic supply voltage |

X2 Motor

| | | |
|---|------|--------------------------|
| 1 | +Up | Power supply voltage |
| 2 | GND | Ground for sensor supply |
| 3 | Ma | Motor phase A |
| 4 | Mb | Motor phase B |
| 5 | Mc | Motor phase C |
| 6 | res. | Reserved |

X3 Profinet - In port**X4 Profinett - Out port**

SVTE-A-S40-CanOpen Stepper Drives

60VDC | 7A
Stepper motors

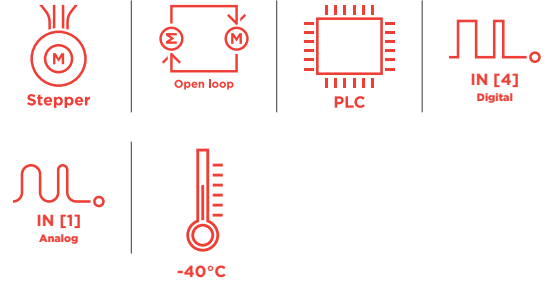
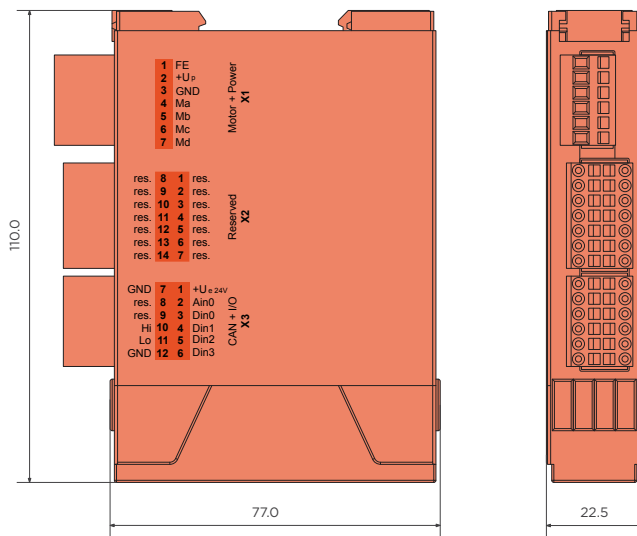

CANopen

| Values | Unit |
|---|---------------------------------|
| Power | |
| 1 Electronic supply voltage U _e | VDC 9..30 |
| 2 Power supply voltage U _p | VDC 9..60 |
| 3 Max. output current | A 20 |
| 4 Continuous output current @ U _p =24VDC | A 7 |
| 5 Continuous output current @ U _p =48VDC | A 6 |
| 6 Output voltage | Up to 85% |
| Motor types | |
| 7 DC motors | no |
| 8 BLDC motors | no |
| 9 Stepper motors | yes |
| Mechanical | |
| 10 Size LxWxH | mm 110 x 22.5 x 77 |
| CAN bus | |
| 11 Protocol | DS301 |
| 12 Device profile | DS402 |
| 13 Galvanically isolated | no |
| Digital input | |
| 14 Number | 4 (Din0..3) |
| Analog inputs | |
| 15 Number | 1 (Ain0) |
| 16 Signal type | 0..10 VDC, 12 Bit, single ended |
| Environment | |
| 17 Operating temperature | °C -40...+70 |

Connection

| X1 Motor | | |
|------------------|---------|--|
| 1 | FE | Functional earth |
| 2 | +Up | Power supply voltage |
| 3 | GND | Ground for sensor supply |
| 4 | Ma | Motor phase A |
| 5 | Mb | Motor phase B |
| 6 | Mc | Motor phase C |
| 7 | Md | Motor phase D |
| X2 Reserved | | |
| 1 | res. | Reserved |
| 2 | res. | Reserved |
| 3 | res. | Reserved |
| 4 | res. | Reserved |
| 5 | res. | Reserved |
| 6 | res. | Reserved |
| 7 | +U5V | 5V output voltage for sensor supply (auxiliary voltage) |
| 8 | res. | Reserved |
| 9 | res. | Reserved |
| 10 | res. | Reserved |
| 11 | res. | Reserved |
| 12 | res. | Reserved |
| 13 | res. | Reserved |
| 14 | GND | Ground for sensor supply (don't connect with system GND) |
| X3 I/O's and CAN | | |
| 1 | +Ue24V | Electronic supply voltage |
| 2 | Ain0 | Analog input 0 |
| 3 | Din0 | Digital input 0 |
| 4 | Din1 | Digital input 1 |
| 5 | Din2 | Digital input 2 |
| 6 | Din3 | Digital input 3 |
| 7 | GND | Ground for electronic supply voltage |
| 8 | res. | Reserved |
| 9 | res. | Reserved |
| 10 | CAN Hi | CAN High |
| 11 | CAN Lo | CAN Low |
| 12 | CAN GND | CAN Ground |

SVTE-A-S45-CanOpen Stepper Drives

60VDC | 7A
Stepper motors

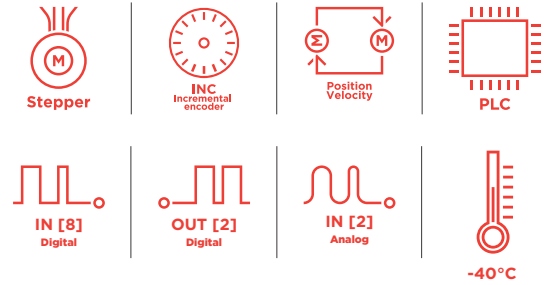
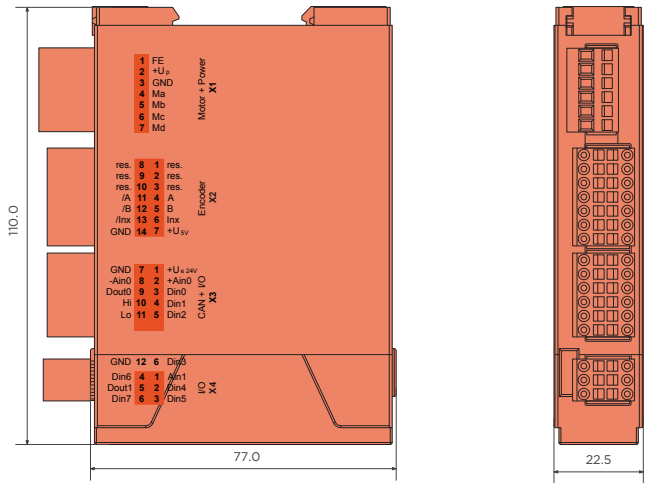

CANopen

| Values | Unit |
|---|--|
| Power | |
| 1 Electronic supply voltage U _e | VDC 9..30 |
| 2 Power supply voltage U _p | VDC 9..60 |
| 3 Max. output current | A 20 |
| 4 Continuous output current @ U _p =24VDC | A 7 |
| 5 Continuous output current @ U _p =48VDC | A 6 |
| 6 Output voltage | Up to 85% |
| Motor types | |
| 7 DC motors | no |
| 8 BLDC motors | no |
| 9 Stepper motors | yes |
| Mechanical | |
| 10 Size LxWxH | mm 110 x 22.5 x 77 |
| CAN bus | |
| 11 Protocol | DS301 |
| 12 Device profile | DS402 |
| 13 Galvanically isolated | no |
| Incremental encoder | |
| 14 Input voltage (24VDC tolerant) | VDC 0..5 |
| 15 Signal type | open collector, single ended, differential |
| Digital input | |
| 16 Number | 8 (Din0..7) |
| Digital output | |
| 17 Number | 2 (Dout0..Dout1) |
| 18 Continuous output current | A 1.5 (Load: resistive, inductive) |
| Analog inputs | |
| 19 Number | 2 (Ain0..1) |
| 20 Signal type - Ain0 | +/- 10 VDC, 12 Bit, differential |
| 21 Signal type - Ain1 | +/- 10 VDC, 12 Bit, single ended |
| Environment | |
| 22 Operating temperature | °C -40...+70 |

Connection

| X1 Motor | | |
|------------------|---------|--|
| 1 | FE | Functional earth |
| 2 | +Up | Power supply voltage |
| 3 | GND | Ground for sensor supply |
| 4 | Ma | Motor phase A |
| 5 | Mb | Motor phase B |
| 6 | Mc | Motor phase C |
| 7 | Md | Motor phase D |
| X2 Inc. encoder | | |
| 1 | res. | Reserved |
| 2 | res. | Reserved |
| 3 | res. | Reserved |
| 4 | A | Inc. encoder, A channel |
| 5 | B | Inc. encoder, B channel |
| 6 | Inx | Inc. encoder, index channel |
| 7 | +U5V | 5V output voltage for sensor supply: encoder |
| 8 | res. | Reserved |
| 9 | res. | Reserved |
| 10 | res. | Reserved |
| 11 | /A | Inc. encoder, A channel inverted |
| 12 | /B | Inc. encoder, B channel inverted |
| 13 | /Inx | Inc. encoder, index channel inverted |
| 14 | GND | Ground for sensor supply (don't connect with system GND) |
| X3 I/O's and CAN | | |
| 1 | +Ue24V | Electronic supply voltage |
| 2 | +Ain0 | Analog input 0, positive |
| 3 | Din0 | Digital input 0 |
| 4 | Din1 | Digital input 1 |
| 5 | Din2 | Digital input 2 |
| 6 | Din3 | Digital input 3 |
| 7 | GND | Ground for electronic supply voltage |
| 8 | -Ain0 | Analog input 0, negative |
| 9 | Dout0 | Digital output 0 |
| 10 | CAN Hi | CAN High |
| 11 | CAN Lo | CAN Low |
| 12 | CAN GND | CAN Ground |
| X4 I/O's | | |
| 1 | Ain1 | Analog input 1 |
| 2 | Din4 | Digital input 4 |
| 3 | Din5 | Digital input 5 |
| 4 | Din6 | Digital output 6 |
| 5 | Dout1 | Digital output 1 |
| 6 | Din7 | Digital input 7 |

SVTE-A-S60-CanOpen Stepper Drives

60VDC | 3.5A
Stepper motors

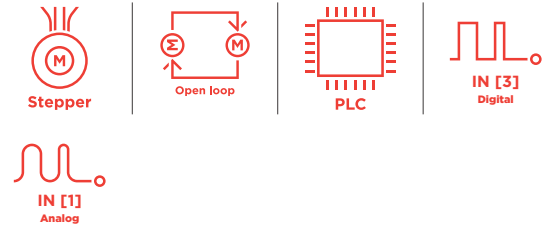
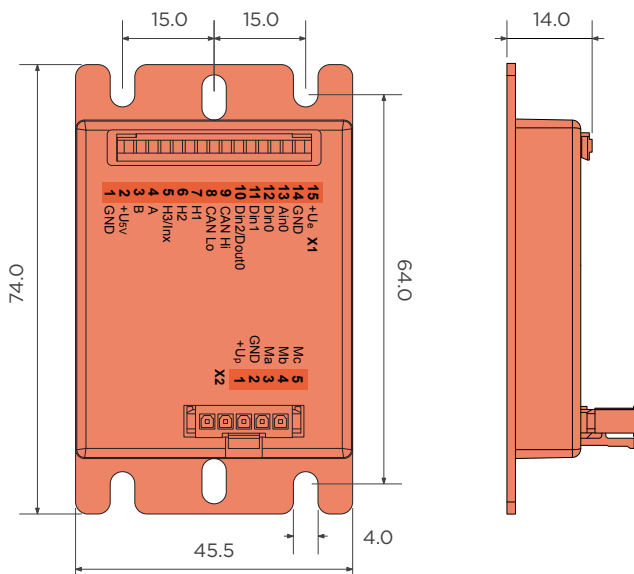

CANopen

| Values | Unit |
|--|---------------------------------|
| Power | |
| 1 Electronic supply voltage Ue | VDC 9..30 |
| 2 Power supply voltage Up | VDC 9..60 |
| 3 Max. output current | A 10 |
| 4 Continuous output current @ Up=24VDC | A 3.5 |
| 5 Continuous output current @ Up=48VDC | A 3 |
| 6 Output voltage | Up to 85% |
| Motor types | |
| 7 DC motors | no |
| 8 BLDC motors | no |
| 9 Stepper motors | yes |
| Mechanical | |
| 10 Size LxWxH | mm 74 x 45.5 x 14 |
| CAN bus | |
| 11 Protocol | DS301 |
| 12 Device profile | DS402 |
| 13 Galvanically isolated | no |
| Digital input | |
| 14 Number | 3 (Din0..2) |
| Analog inputs | |
| 15 Number | 1 (Ain0) |
| 16 Signal type | 0..10 VDC, 12 Bit, single ended |
| Environment | |
| 17 Operating temperature | °C -25...+70 |

Connection

X3 I/O's and CAN

| | | |
|----|--------|---|
| 1 | GND | Ground of the auxiliary voltage (don't connect with system GND) |
| 2 | +U5V | 5V output voltage (auxiliary voltage) |
| 3 | res. | Reserved |
| 4 | res. | Reserved |
| 5 | res. | Reserved |
| 6 | res. | Reserved |
| 7 | res. | Reserved |
| 8 | CAN Lo | CAN Low |
| 9 | CAN Hi | CAN High |
| 10 | Din2 | Digital input 2 |
| 11 | Din1 | Digital input 1 |
| 12 | Din0 | Digital input 0 |
| 13 | Ain0 | Analog input 0 |
| 14 | GND | Ground for electronic supply voltage |
| 15 | +Ue | Electronic supply voltage |

X2 Motor

| | | |
|---|-----|--------------------------|
| 1 | +Up | Power supply voltage |
| 2 | GND | Ground for sensor supply |
| 3 | Ma | Motor phase A |
| 4 | Mb | Motor phase B |
| 5 | Mc | Motor phase C |
| 6 | Md | Motor phase D |

SVTE-A-S65-CanOpen Stepper Drives

60VDC | 3.5A
Stepper motors

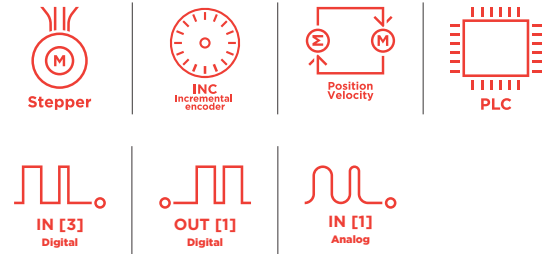
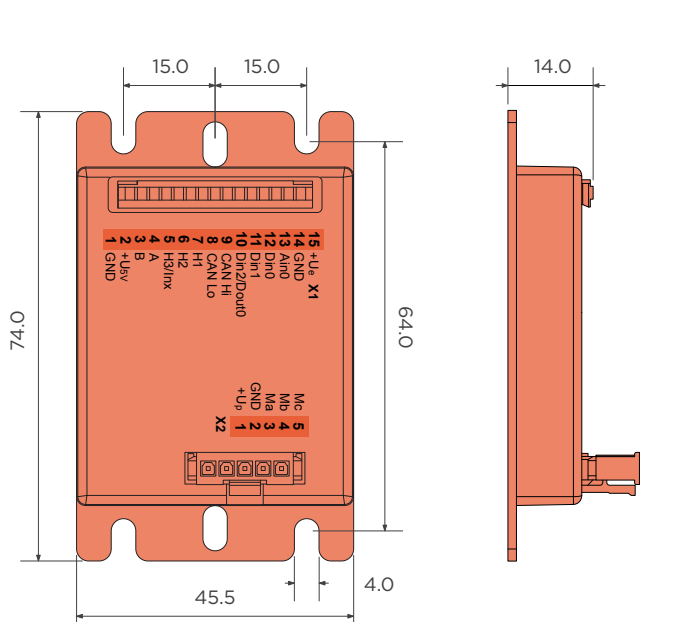

CANopen

| Values | Unit |
|--|---|
| Power | |
| 1 Electronic supply voltage Ue | VDC 9..30 |
| 2 Power supply voltage Up | VDC 9..60 |
| 3 Max. output current | A 10 |
| 4 Continuous output current @ Up=24VDC | A 3.5 |
| 5 Continuous output current @ Up=48VDC | A 3 |
| 6 Output voltage | Up to 85% |
| Motor types | |
| 7 DC motors | no |
| 8 BLDC motors | no |
| 9 Stepper motors | yes |
| Mechanical | |
| 10 Size LxWxH | mm 74 x 45.5 x 14 |
| CAN bus | |
| 11 Protocol | DS301 |
| 12 Device profile | DS402 |
| 13 Galvanically isolated | no |
| Incremental encoder | |
| 14 Input voltage | VDC 0..5 |
| 15 Signal type | open collector, single ended |
| Digital input | |
| 16 Number | 3 (Din0..2); Din2 parallel with Dout0 (must not exceed electronic supply voltage) |
| Digital output | |
| 17 Number | 1 (Dout0); Dout0 parallel with Din2 |
| 18 Continuous output current | 1.5 (Load: resistive, inductive) |
| Analog inputs | |
| 19 Number | 1 (Ain0) |
| 20 Signal type - Ain0 | +/- 10 VDC, 12 Bit, single ended |
| Environment | |
| 22 Operating temperature | °C -25...+70 |

Connection

X3 I/O's and CAN

| | | |
|----|------------|---|
| 1 | GND | Ground of the auxiliary voltage (don't connect with system GND) |
| 2 | +U5V | 5V output voltage for supply encoder |
| 3 | B | Inc. encoder, B channel |
| 4 | A | Inc. encoder, A channel |
| 5 | Inx | Inc. encoder, index channel |
| 6 | res. | Reserved |
| 7 | res. | Reserved |
| 8 | CAN Lo | CAN Low |
| 9 | CAN Hi | CAN High |
| 10 | Din2/Dout0 | Digital input 2 / Digital output 0 |
| 11 | Din1 | Digital input 1 |
| 12 | Din0 | Digital input 0 |
| 13 | Ain0 | Analog input 0 |
| 14 | GND | Ground for electronic supply voltage |
| 15 | +Ue | Electronic supply voltage |

X2 Motor

| | | |
|---|-----|--------------------------|
| 1 | +Up | Power supply voltage |
| 2 | GND | Ground for sensor supply |
| 3 | Ma | Motor phase A |
| 4 | Mb | Motor phase B |
| 5 | Mc | Motor phase C |
| 6 | Md | Motor phase D |